

<b>Chapter 17. Trail Steps</b> .....	<b>17-1</b>
<b>17.1. Considerations</b> .....	<b>17-1</b>
17.1.1. User Types.....	17-1
17.1.2. Carriages and Landings .....	17-1
17.1.3. Handrails .....	17-1
<b>17.2. Step Layout</b> .....	<b>17-2</b>
<b>17.3. Step Calculations</b> .....	<b>17-3</b>
<b>17.4. Step Construction</b> .....	<b>17-11</b>
17.4.1. Wooden Steps.....	17-11
17.4.2. Curved Steps.....	17-15
17.4.3. Rock Steps .....	17-21
17.4.4. Rock and Riser Steps.....	17-22
17.4.5. Rock Framed Steps.....	17-24
17.4.6. Overlapping Rock Steps.....	17-26
17.4.7. Equestrian Steps .....	17-26
17.4.8. Interlocking and Cribbed Steps .....	17-29
17.4.8.1. Interlocking Steps.....	17-29
17.4.8.1. Full Cribbed Steps.....	17-30
17.4.9. Cable Steps.....	17-35
17.4.10. Cutout Stringer Stairways.....	17-37
17.4.11. Hardening the Step Approach .....	17-41

## Figures

Figure 17.1 - Field Step Layout with Clinometer .....	17-5
Figure 17.2 – Step Calculations (Rise and Run) .....	17-6
Figure 17.3 - Step Calculations (Decreasing Horizontal Run) .....	17-7
Figure 17.4 – Step Calculations (Increasing Horizontal Run).....	17-8
Figure 17.5 - Step Calculations without Landing Transition .....	17-9
Figure 17.6 - Step Calculations with Landing Transition .....	17-10
Figure 17.7 – Wooden Steps.....	17-13
Figure 17.8 - Wooden Steps Continued .....	17-14
Figure 17.9 - Curve Step Layout .....	17-17
Figure 17.10 - Curve Step Layout Continued .....	17-19
Figure 17.11 - Curve Step Construction.....	17-20
Figure 17.12 - Rock and Riser Steps .....	17-23

Figure 17.13 - Rock Framed Steps .....	17-25
Figure 17.14 - Overlapping Rock Steps .....	17-27
Figure 17.15 - Equestrian Steps.....	17-28
Figure 17.16 - Interlocking Steps .....	17-31
Figure 17.17 - Double Interlocking Steps .....	17-32
Figure 17.18 - Cribbed Steps .....	17-34
Figure 17.19 - Cable Steps .....	17-38
Figure 17.20 - Cutout Stringer Stairway Layout .....	17-40
Figure 17.21 - Cutout Stringer Stairway, Continued.....	17-42
Figure 17.22 – Hardening the Step Approach.....	17-43

**Photos**

Photo 17.1 - Step Handrails .....	17-2
Photo 17.2 - Wooden Steps .....	17-12
Photo 17.3 - Rock Steps .....	17-21
Photo 17.4 - Rock Framed Steps .....	17-24
Photo 17.5 - Single Interlocking Steps .....	17-29
Photo 17.6 - Double Interlocking Steps.....	17-30
Photo 17.7 - Wooden Cribbed Steps.....	17-30
Photo 17.8 - Cable Steps .....	17-35
Photo 17.9 - Cutout Stringer Stairway .....	17-37

## Chapter 17. Trail Steps

When the maximum sustainable grade or less between control points cannot be achieved through curvilinear alignment or turns, steps can be an appropriate design solution. (See Chapter 5, *Principles of Trail Layout and Design*.) Steps may also be required when the parent material is not stable enough to retain its position on the landform without some means of containment, or where obstructions such as large rocks and roots must be constructed over rather than through. If there is a significant elevation difference between the starting and ending points of the trail or between major control points, as well as a limited landbase, steps can be the only possible solution to providing public access in a sustainable way. Conditions that often require the use of steps include coastal access trails that connect steep bluffs to the beach, deep canyon trails, or deeply carved valleys. The purpose of steps is to provide a stable vertical rise on a trail that will allow lower sustainable trail grades between step carriages.

### 17.1. Considerations

#### 17.1.1. User Types

Steps can create a barrier to a user with a mobility impairment and cause problems for equestrians and mountain bikers. Steps should be avoided when designing a new trail or reroute. When steps are required, design and construct steps that are user-friendly and not hazardous.

#### 17.1.2. Carriages and Landings

If possible, steps should be constructed in sections of three or more steps. The installation of multiple steps in sequence is defined as a step carriage. A single or double step on a trail can create a trip hazard since trail users do not typically adapt their gait to one or two steps as well as they do to a series of steps. When the hillslope dictates multiple carriages of steps due to changes in the slope grade, there should be a break or landing between the carriages. Landings should be a minimum of 3 feet in length, provide a noticeable break in the step carriage, and provide a rest area for users. Landings are important when the step tread depth changes between carriages due to a change in the hillslope grade. Trail users need to adjust their gait or stride to compensate for the tread depth, and the landing helps them reset their stride.

#### 17.1.3. Handrails

Handrails on steps are recommended in many situations including when the steps are narrow or experience high usage; when there is an adjacent steep drop-off; or where accessibility or resource protection are a concern. Handrails aid hikers in ascending and descending steps. Handrails also give trail users a sense of security. Handrails must have a structurally sound design and be constructed with materials that match the local architecture and are aesthetically pleasing. (See Photo 17.1.)



**Photo 17.1 - Step Handrails**

## **17.2. Step Layout**

Steps should be designed so they will be used and not avoided by the hiker. They must be in the most appropriate location and have an evenly spaced rise and run. When hikers bypass steps, they create volunteer trails that others trail users soon follow, resulting in unsightly eroded rills and gullies. If steps are installed on a slope where the grade is insufficient to warrant their use, trail users may traverse around the steps because the hillslope is easier to negotiate than the steps. Due to the variety of conditions that dictate the use of steps, there is no set percentage of hillslope or linear grade where steps should not be used. However, if the hillslope or linear grade is less than 45%, alternatives to steps should be considered.

Trail users will sometimes avoid steps that are well placed and constructed. To prevent users from leaving the steps, native material, such as downed trees and large rocks, are placed adjacent to the step carriage. Rock drains placed along the edge of the steps, to facilitate water runoff from the carriage, can also act as a deterrent.

To improve user safety, increase accessibility, and reduce the number of users traversing around steps, each step must have the same rise and run. The rise should be either 7 or 8 inches and the run (tread area) should be between 13 and 18 inches deep to facilitate a smooth and predictable gait. Properly designed and constructed steps can be negotiated without the user having to look at the steps and where their feet are placed. Each tread must be firm and have a uniform surface to provide secure footing. Treads also need to be slightly insloped or outsloped to provide proper drainage.

### 17.3. Step Calculations

Brush and clear the location for the steps prior to construction. If steps are being replaced, the old steps are removed and disposed of properly. To calculate the total rise and run of the step carriage, first identify the starting and ending elevations. The simplest method of calculation is to use an Abney hand level or clinometer and a tape measure. The person performing this task first measures the height of their eye level from the ground. Stand on level ground and have a coworker hold an extended tape measure vertically (plumb) so the numbers are visible. The end of the tape measure should be touching the ground. Sight on the tape measure with a clinometer and hold the clinometer at zero or level on the tape measure. Have the coworker slide a finger along the face of the tape measure until it intersects with the horizontal line at zero percent reading on the clinometer. The measurement at this intersection is the distance from eye level to the ground. This measurement is used to determine the required elevation rise when laying out steps. (See Figure 17.1.)

Next, stand at the starting point of the step carriage, place a pin flag at that location, and sight the clinometer at zero percent (level) on to the hillslope. Have the coworker stand at that location on the slope. The bottom of their boots should be level with the zero percent (level) reading on the clinometer. The coworker may need to level-off a small landing at that location with their feet to facilitate standing erect and taking further measurements. Once they have established a level area at the previously sighted elevation, they install a second pin flag at this location. (See Figure 17.2.)

Next, the length or run of that step segment is determined using a tape measure. For accuracy, the tape measure must be held horizontally level when taking this measurement. By holding one end of the tape measure at the base of the second pin flag on the hillslope, and the other end at the eye level of the person using the clinometer, a reasonably level measurement can be taken. When the tape measure is held at eye level, it is important that the end of the tape be plumb or directly over the first pin flag. While this measurement is being taken, a plumb bob can be held in line with the first pin flag to ensure the end of the tape is directly over it.

Once this measurement is completed, record the vertical rise and the horizontal run of this segment. Next, the person with the clinometer moves up the slope to the second pin flag, and takes another level sighting on the hillslope. The coworker levels and marks that position with a third pin flag, and the horizontal measurement is taken and recorded. This process is repeated until the person's eye level is equal to or exceeds the top of the step carriage. If the rise from the last flag location to the top of the carriage is less than eye level, the coworker standing at the top of the carriage elevation holds the tape measure so its end is resting against the ground at the top elevation of the carriage. The person using the hand level or clinometer then sights on the body of their coworker and the tape measure at their eye level or (zero percent). (See Figure 17.2.) The height on the tape measure is then subtracted from the known height of the person's eye level. This number is the vertical rise between the pin flag where the person with the clinometer is standing and the top of the last carriage segment. The

horizontal measurement is taken from the horizontal reference (i.e., reference location on the body of the coworker) to the eye level of the person using the clinometer.

The total elevation gain (rise) is determined by adding the vertical measurements together. Once the total elevation gain is calculated, divide it by the desired step height to calculate the number of steps required for the carriage. (See Figure 17.2.)

The total length of the carriage is determined by adding all of the horizontal measurements. To determine the average tread depth of the steps, the length of the carriage is divided by the number of steps minus one. One step is eliminated because the top step in the carriage ends at trail grade. (See Figure 17.2.)

Step treads should be between 13 and 18 inches deep. If the step tread exceeds 18 inches, the length of the carriage must be reduced. To reduce the length, re-grade the approaches to the step carriage to move the starting and ending points closer to each other. The starting point at the bottom of the step carriage is moved further into the hillslope thus shortening the horizontal length of the carriage. (See Figure 17.3.) If the tread depth is less than 13 inches, lengthen the run by adjusting the starting and ending points of the carriage. (See Figure 17.4.) If the slope of the hillside has a consistent grade, the steps will have the same tread depth for the entire carriage. (See Figure 17.5.)

Often the slope of the hillside into which the carriage is being constructed varies in grade. For example, if the hillslope grade is 50% for the first 6 feet of elevation rise and 70% for the final 8 feet of the elevation rise, it is difficult to even out the rise and run over these two sections and requires more excavation and fill than is desirable. For these conditions, calculate the rise and run of the two step carriages separately and install a landing between the carriages to allow trail users to adjust their stride. (See Figure 17.6). The landing between carriages must be a minimum of 36 inches deep to allow for stride adjustment. On equestrian trails, the length of the landing must be longer to accommodate the size of the horse. (See the section on equestrian steps in this chapter.)

STEP 1, STANDING ERECT ON LEVEL GROUND HAVE CO WORKER HOLD A TAPE MEASURE VERTICALLY (PLUMB) WITH THE NUMBERS FACING YOU. THE END OF THE TAPE IS TOUCHING THE GROUND. SIGHT THROUGH THE CLINOMETER AT ZERO OR LEVEL WHILE LOOKING AT THE TAPE MEASURE. HAVE CO WORKER SLIDE THEIR FINGER ALONG THE FACE OF THE TAPE UNTIL IT INTERSECTS WITH YOUR HORIZONTAL (ZERO) SIGHT PICTURE. READ THE MEASUREMENT AT THIS INTERSECTION. THIS MEASUREMENT (67" EXAMPLE) IS THE DISTANCE FROM YOUR EYE HEIGHT TO THE GROUND. THIS MEASUREMENT IS USED TO DETERMINE ELEVATION WHEN LAYING OUT STEPS.

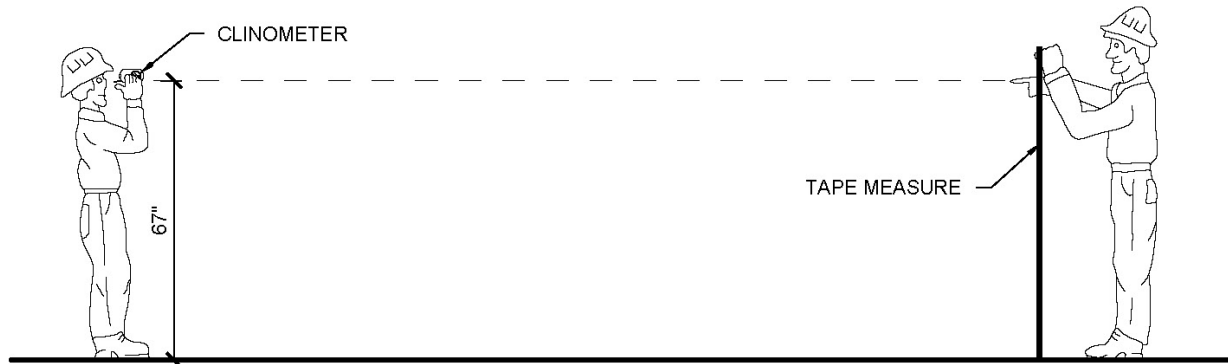

**Figure 17.1 - Field Step Layout with Clinometer**



## FIELD STEP LAYOUT WITH CLINOMETER

CALIFORNIA STATE PARKS

NOT TO SCALE

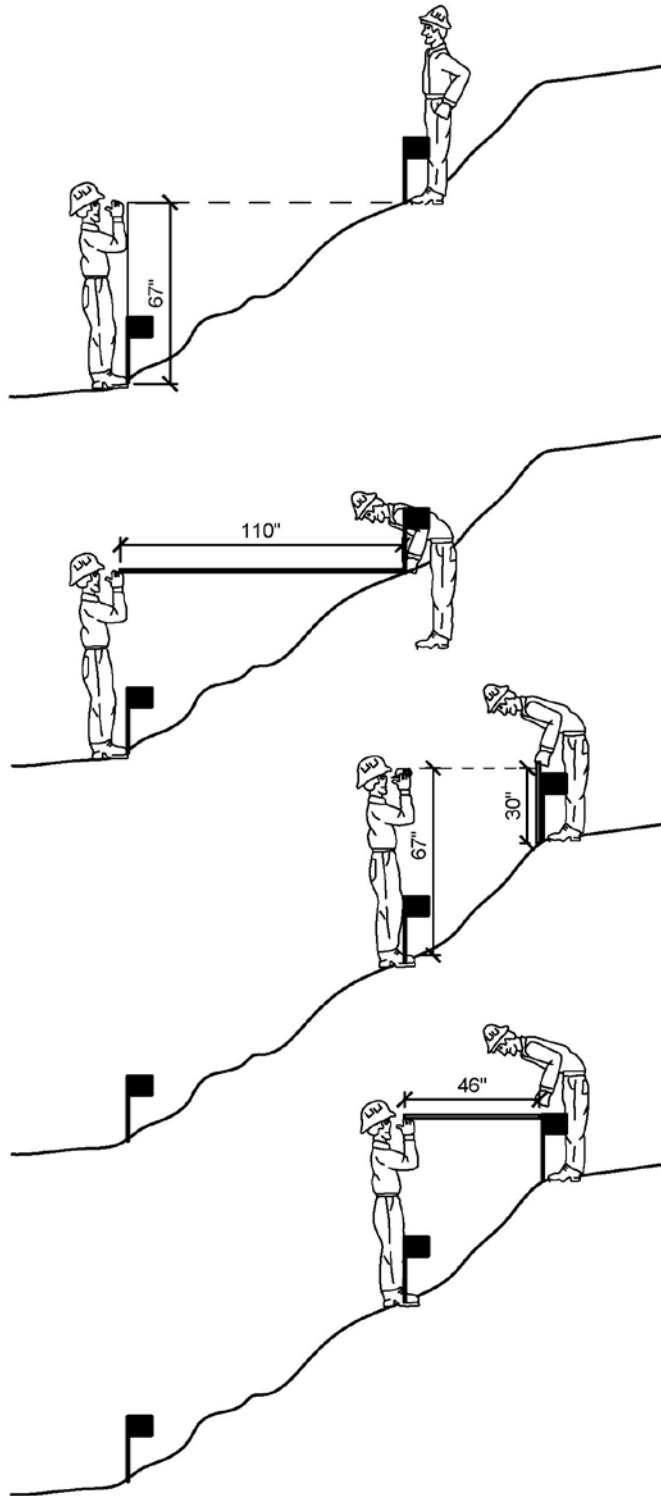

STEP 1. STANDING AT THE BASE OF THE SLOPE SET PIN FLAG AT BASE OF FEET IN A VERTICAL (PLUMB) LINE FROM YOUR EYE, USE A CLINOMETER TO SIGHT LEVEL ONTO THE HILLSLOPE. HAVE CO-WORKER STAND AT THAT LOCATION/ELEVATION AND LEVEL IT OFF SO THEY HAVE A LEVEL PLACE TO STAND. THAT RISE IS THE SAME AS THE DISTANCE FROM THE BOTTOM OF YOUR BOOT TO YOUR EYE. HAVE CO-WORKER PLACE A PIN FLAG AT THAT LOCATION. RECORD THAT RISE.

STEP 2. USE A TAPE MEASURE TO MEASURE THE HORIZONTAL DISTANCE FROM PIN FLAG AT YOUR FEET TO THE LOCATION ON THE HILLSLOPE WHERE YOU PLACED THE SECOND PIN FLAG (KEEPING THE TAPE MEASURE LEVEL WITH YOUR EYE AND STRAIGHT OVER THE PIN FLAG). USE PLUMB BOB IF NECESSARY TO KEEP TAPE OVER PIN FLAG.) RECORD THAT DISTANCE/RUN.

STEP 3. MOVE TO THE SECOND PIN FLAG POSITION ON THE SLOPE AND RE-OCCUPY THE EXACT FOOTSTEPS OF YOUR CO-WORKER. CO-WORKER MOVES TO THE TOP OF THE SLOPE AND PLACES A THIRD PIN FLAG. SHOOT ANOTHER HORIZONTAL LINE ON THE BODY OF YOUR CO-WORKER. CO-WORKER MEASURES FROM THE LOCATION TO THE GROUND. SUBTRACT THAT DISTANCE FROM 67" TO OBTAIN RISE TO THE TOP OF SLOPE.  $67" - 30" = 37"$ . ADD THE TWO RISE MEASUREMENTS TO GET THE TOTAL RISE  $67" + 37" = 104"$ . DIVIDE  $104"$  BY  $8"$  OBTAIN NO. OF STEPS. 13 STEPS.

STEP 4. USE A TAPE MEASURE TO MEASURE THE HORIZONTAL DISTANCE FROM THE SECOND PIN FLAG AT YOUR FEET TO THE HORIZONTAL LOCATION SIGHTED ON YOUR CO-WORKER (KEEPING THE TAPE MEASURE LEVEL WITH YOUR EYE.) ADD THAT RUN TO THE PREVIOUS RUN MEASUREMENT.  $110" + 46" = 156"$ . DIVIDE THE RUN BY THE NO. OF STEPS MINUS 1 TO OBTAIN THE TREAD SIZE  $156"/12 = 13"$ .

Figure 17.2 – Step Calculations (Rise and Run)



## STEP CALCULATIONS (RISE AND RUN)

CALIFORNIA STATE PARKS

NOT TO SCALE



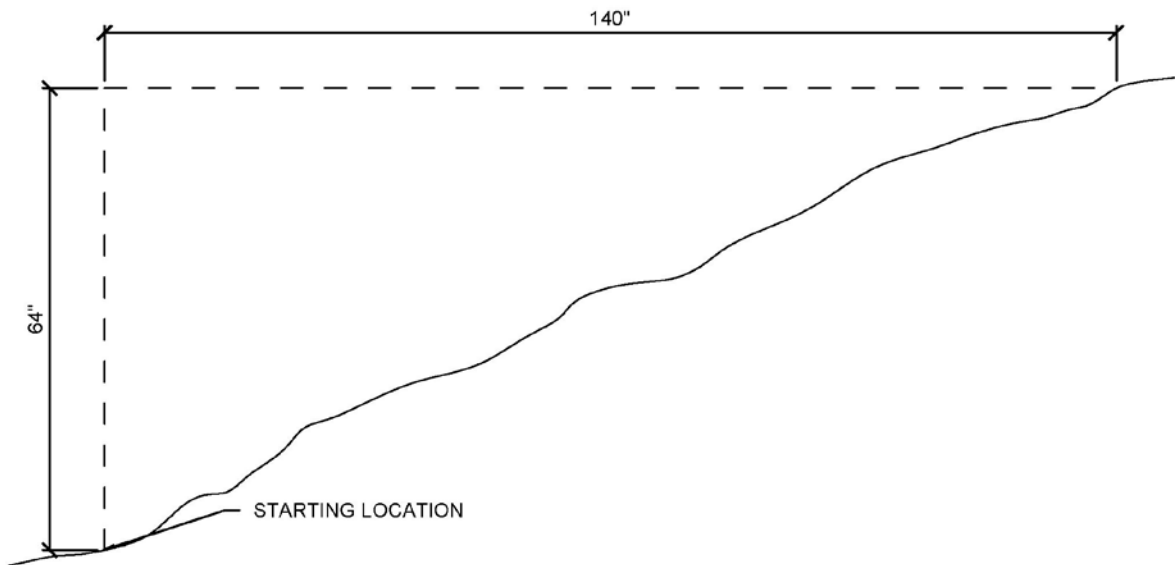

64" / 8 = 8 STEPS  
 8-1 = 7 TREADS  
 140" / 7 = 20"  
 TREADS

NOTE: THE TREAD DEPTH EXCEEDS THE 18" MAXIMUM. MULTIPLY 18"X7 TO DETERMINE MAXIMUM HORIZONTAL DISTANCE. 18"X7 = 126". SUBTRACT 126" FROM 140" TO DETERMINE THE DISTANCE THE RUN NEEDS TO BE SHORTENED. 140 - 126 = 14" THIS IS ACCOMPLISHED BY STARTING THE STEP CARRIAGE 14" FURTHER INTO THE HILLSLOPE.

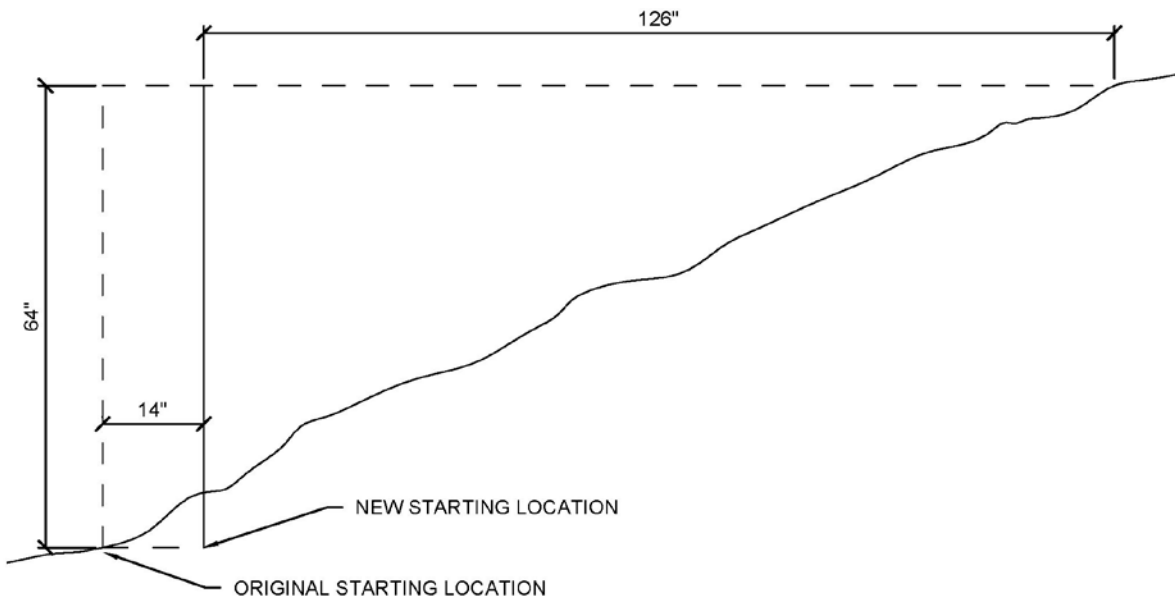

64" / 8 = 8 STEPS  
 8-1 = 7 TREADS  
 126" / 7 = 18"  
 TREADS

**Figure 17.3 - Step Calculations  
 (Decreasing Horizontal Run)**



**STEP CALCULATIONS (DECREASING HORIZONTAL RUN)**

CALIFORNIA STATE PARKS

NOT TO SCALE

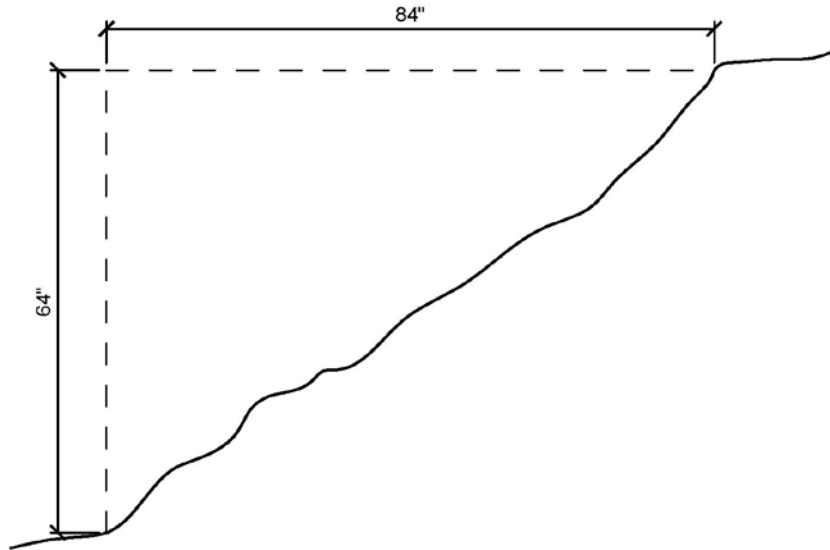

$64'' / 8 = 8$  STEPS  
 $8 - 1 = 7$  TREADS  
 $84'' / 7 = 12''$  TREADS

NOTE: THE TREAD LENGTH IS LESS THAN THE 13" MINIMUM. MULTIPLY 13" X 7 TO DETERMINE MINIMUM HORIZONTAL DISTANCE.  
 $13'' \times 7 = 91''$ . SUBTRACT 84" FROM 91" TO DETERMINE THE DISTANCE THE RUN NEEDS TO BE LENGTHENED.  $91'' - 84'' = 7''$   
 THIS IS ACCOMPLISHED BY ENDING THE STEP CARRIAGE 7" FURTHER INTO THE HILLSLOPE.

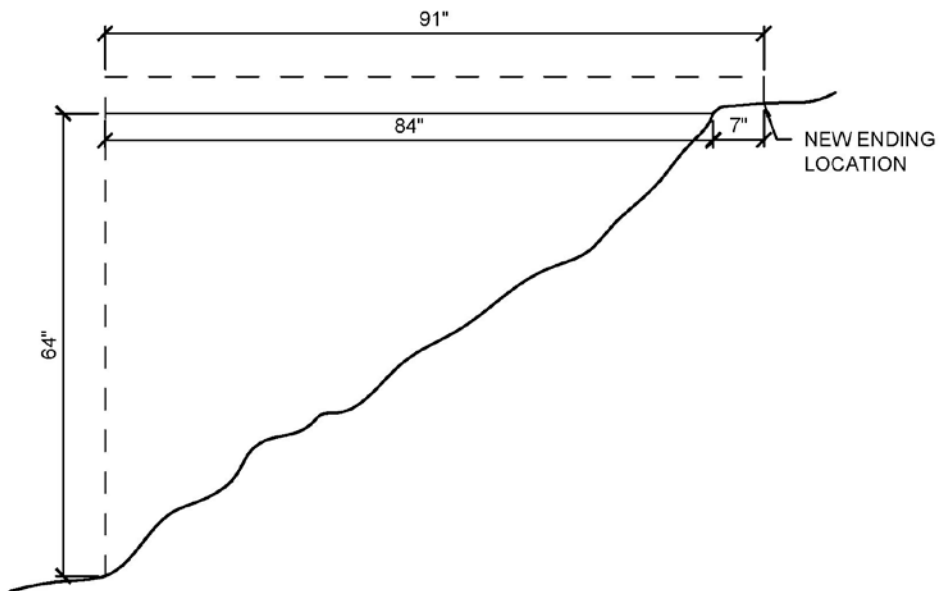

$64'' / 8 = 8$  STEPS  
 $8 - 1 = 7$  TREADS  
 $91'' / 7 = 13''$  TREADS

**Figure 17.4 – Step Calculations (Increasing Horizontal Run)**



**STEP CALCULATIONS (INCREASING HORIZONTAL RUN)**

CALIFORNIA STATE PARKS

NOT TO SCALE

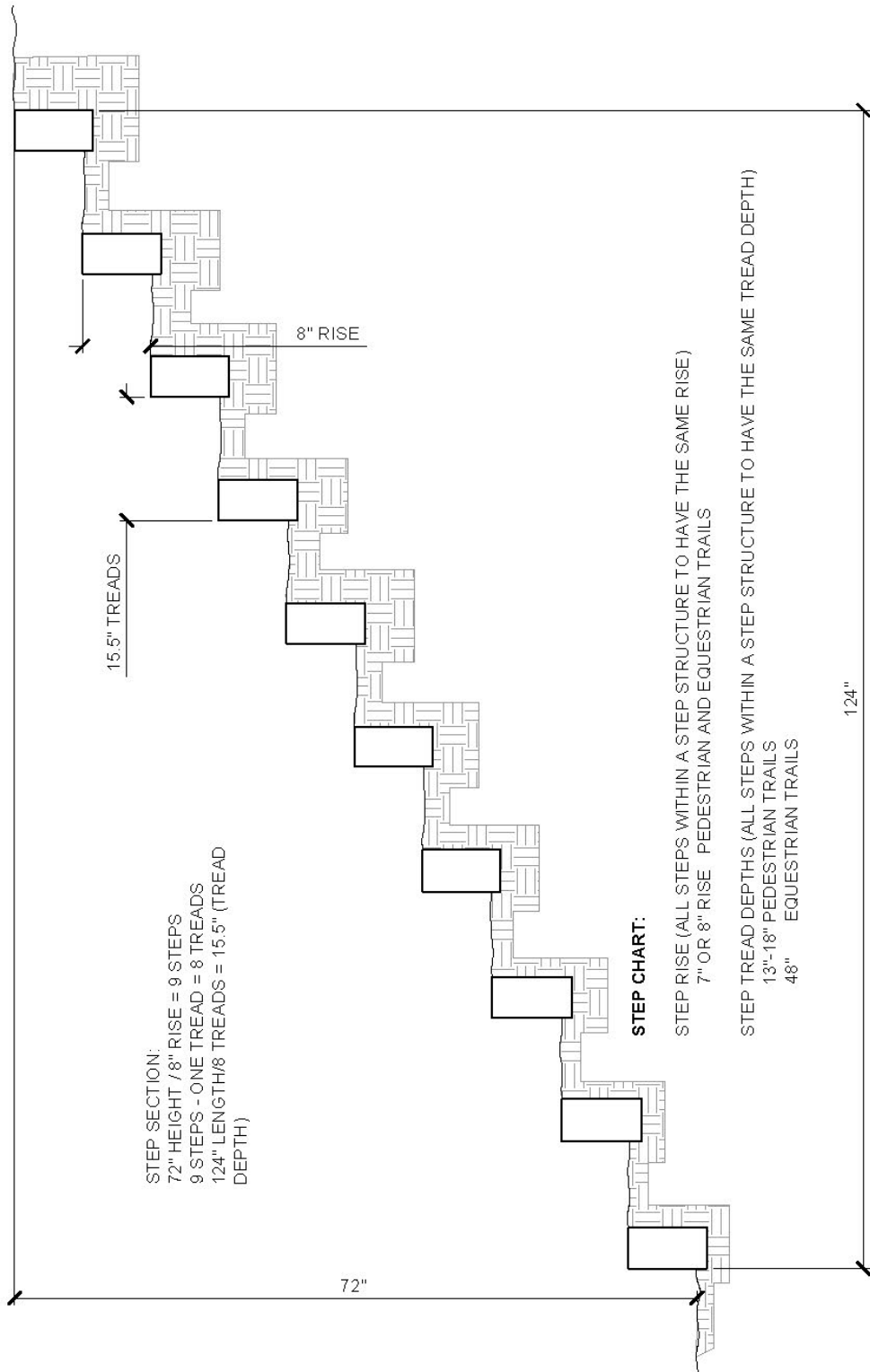

Figure 17.5 - Step Calculations without Landing Transition



STEP CALCULATIONS WITHOUT LANDING TRANSITION

CALIFORNIA STATE PARKS

NOT TO SCALE

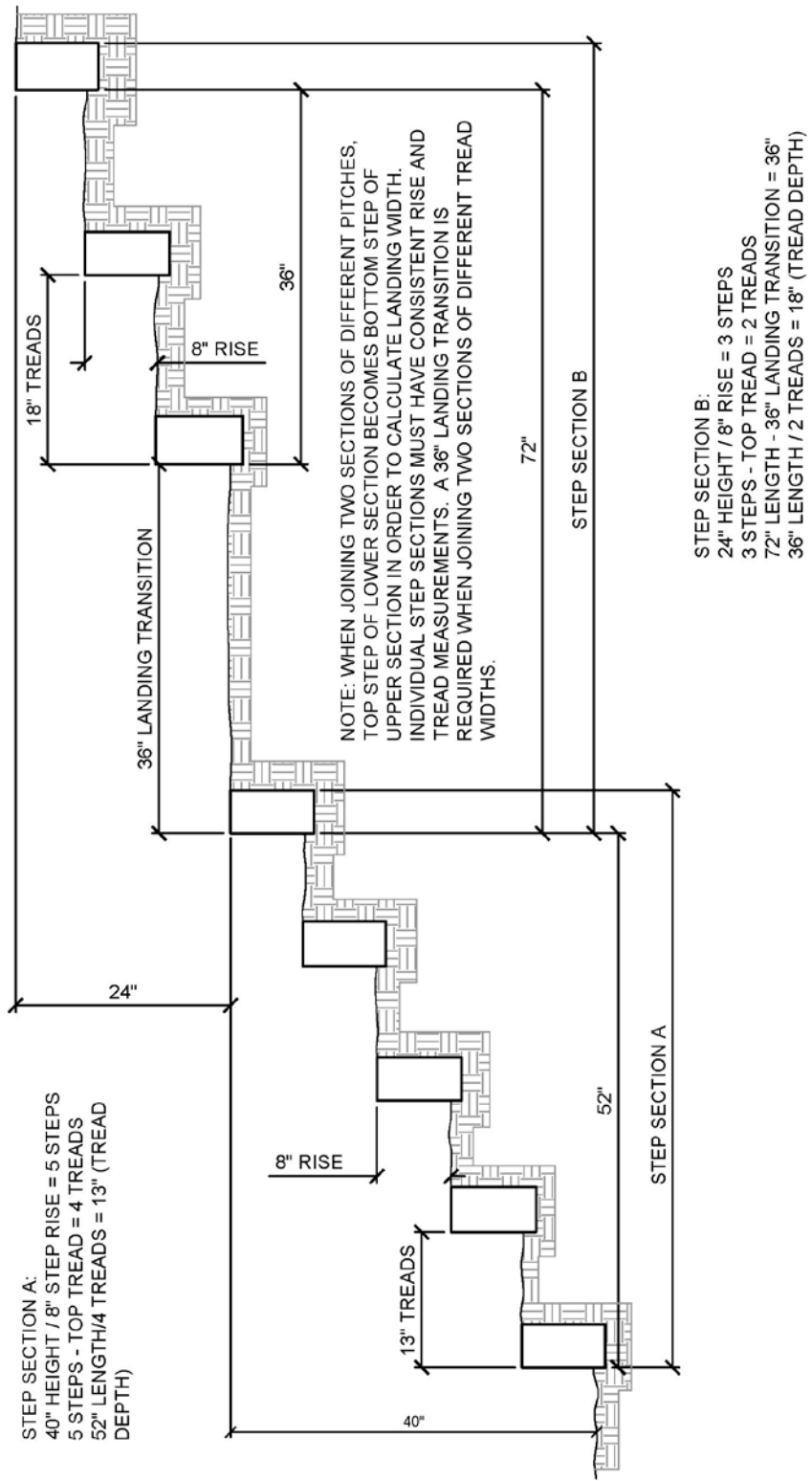

**STEP CHART:**

STEP RISE (ALL STEPS WITHIN A STEP STRUCTURE TO HAVE THE SAME RISE)  
 7" OR 8" RISE PEDESTRIAN AND EQUESTRIAN TRAILS

STEP TREAD DEPTHS (ALL STEPS WITHIN A STEP STRUCTURE TO HAVE THE SAME TREAD DEPTH)  
 13"-18" PEDESTRIAN TRAILS  
 48" EQUESTRIAN TRAILS

TRANSITION LANDING DEPTHS  
 36" PEDESTRIAN TRAILS  
 96" EQUESTRIAN TRAILS

**Figure 17.6 - Step Calculations with Landing Transition**



**STEP CALCULATIONS WITH LANDING TRANSITION**

CALIFORNIA STATE PARKS

NOT TO SCALE

## 17.4. Step Construction

A variety of designs and materials are used to construct trail steps. The design and materials used should provide the best design solution, match the local architecture, and blend into the surrounding environment.

### 17.4.1. Wooden Steps

For durability and ease of construction, wooden steps are constructed with rough sawn redwood, cedar, pressure treated lumber, or plastic lumber. (See Photo 17.2.) The length of the lumber needs to be no less than 6 inches longer than the desired step width and have a minimum end dimension of 4- x 8-inch for a 7-inch rise and 4- x 10-inch for an 8-inch rise. Wooden steps must have an angular face to provide more secure footing for the trail user. Round materials, such as peeler cores, should be avoided in this application because they offer less traction and no outside edge for the sole of footwear to grip. Wooden steps are a good design for stable slopes with low to moderate pedestrian traffic. (See Figures 17.7 and 17.8.)

To install wooden steps, start at the bottom of the carriage where the initial layout identified the beginning of the steps. The initial step is placed into a shallow footing approximately 1 inch in depth that is excavated and sized for the specific step. If the steps are being installed with an inslope or outslope, the footing excavation needs to extend into the cut bank 6 inches. If the steps are being installed straight up the hillslope (through cut), the footing excavation needs to extend into the hillslope 6 inches on both sides of the step. Burying the end of the step 6 inches into the hillslope prevents it from being exposed, which can divert sheet flow and erode the uphill side of the trail. (See Figures 17.7 and 17.8.)

The footing should be level from front to back, have the same cross slope as the desired finished step, and be perpendicular to the trail alignment. Do not over-excavate, as it creates the need for fill material to achieve the desired elevation. Any loose soil will result in an unstable foundation. Therefore, the soil in the bottom of the footing should be compacted for stability. Wooden steps should span the entire trail width, ensuring that backfilled soil is contained and that there is no room for trail users to circumvent the step. Prior to placing the step into the footing, drill 9/16-inch pilot holes on center through the step, approximately 6 inches from each end of the step. The step is placed in the footing and checked with a carpenter's level to ensure that it is level from front to back and has the desired cross slope. Once the step is placed in the footing, it is pinned with 5/8- x 36-inch rebar.



**Photo 17.2 - Wooden Steps**

With the step secured, the uphill side is backfilled with soil from the next step excavation. If more durable backfill material such as crushed rock is required, install it behind the step and export the soil from the step excavation above to a suitable location. When steps are placed in a series, the bottom of the upper step is one inch lower than the top of the lower step. This overlap reduces undermining of the upper step by mechanical wear, helps lock in backfill material, and prevents water from collecting behind the steps. For proper drainage, the final elevation and grade of the backfill material or tread should have the same cross slope as the steps. Often, a drain or ditch is constructed to channel runoff from the steps. Large angular rocks are best for filling any ditch, as they provide the most voids to allow water to pass and discourage trail users from walking outside the steps. (See Figures 17.7 and 17.8.)

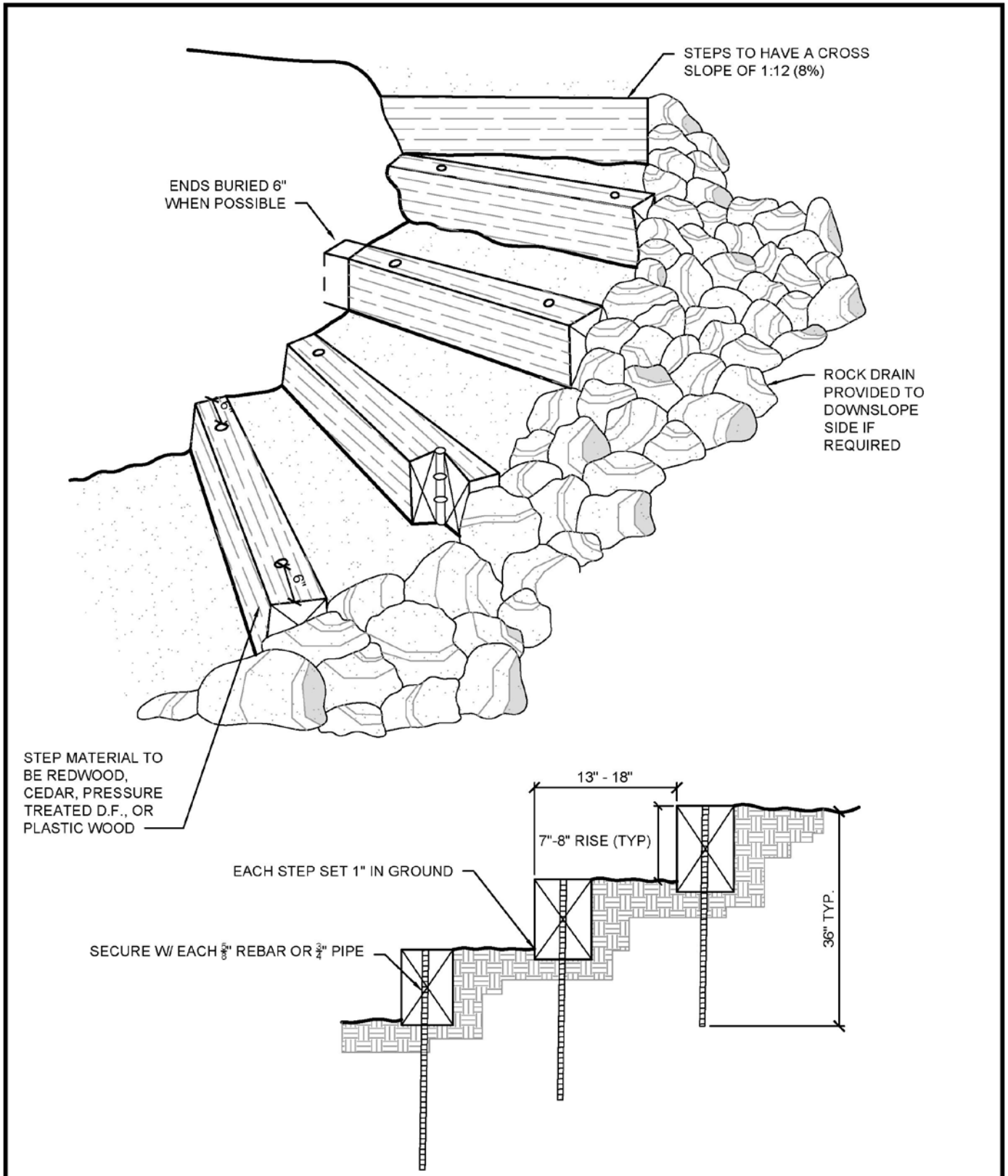

**Figure 17.7 – Wooden Steps**



**WOODEN STEPS**  
**CALIFORNIA STATE PARKS**

NOT TO SCALE

OUTSLOPE

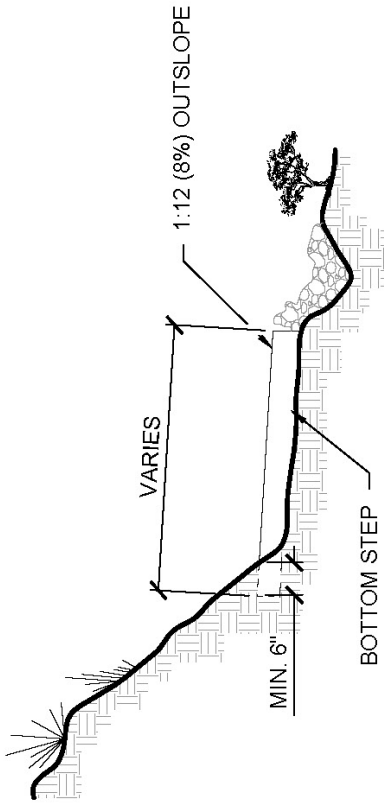

OUTSLOPE IN THROUGH CUT

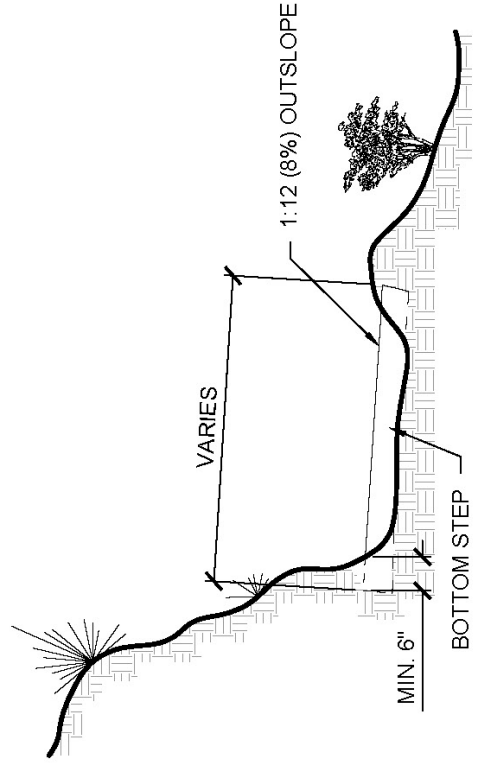

INSLOPE

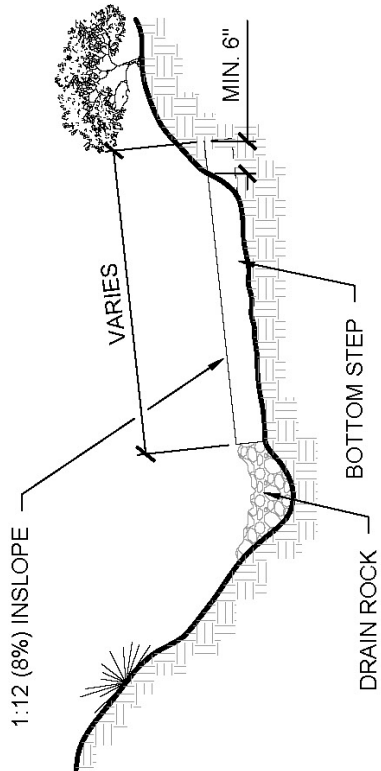

Figure 17.8 - Wooden Steps Continued



### WOODEN STEPS CONTINUED

CALIFORNIA STATE PARKS

NOT TO SCALE



#### 17.4.2. Curved Steps

Sometimes it is not practical or desirable to install a step carriage in a straight line. A feature such as a rock outcropping or tree may prohibit installing a step carriage in a linear fashion. For aesthetic purposes, it may also be preferable to have the steps curve up the hillslope in keeping with the outdoor setting. In this discussion, curved steps are being applied to wooden steps; however, most of the types of steps discussed in this chapter can be installed in a curved fashion.

It was previously mentioned that individual steps within a carriage should each have an equal rise (7 to 8 inches) and tread depth (13 to 18 inches). With a curved step layout, the depth of the tread will need to be tapered so the inside of the step is narrower than the outside. Since the minimum step tread depth is 13 inches, the depth of the inside of the step tread cannot be less than 13 inches. Since the maximum step tread depth is 18 inches, the outside of the step tread cannot be greater than 18 inches. The middle of the step tread would be 15 1/2 inches (i.e.,  $18 - 13 = 5$ ;  $5 \div 2 = 2\ 1/2$ ;  $2\ 1/2 + 13 = 15\ 1/2$ ). With this layout, a person walking up the inside (13 inches), middle (15 1/2 inches), or outside (18 inches) of the step carriage will have a consistent tread depth. See Figure 17.11 for reference charts on tread depths.

Given these parameters, the maximum taper is an inside tread depth of 13 inches and an outside tread depth of 18 inches. In most applications, the 18-inch outside tread depth is used to achieve a more acute curve to the step carriage. An outside tread depth of less than 15 inches would produce such a negligible curve that it is not practical.

To layout a curved step carriage, first identify where the step carriage will begin and end. Mark these two locations by driving form stakes in the ground. The stakes identify the center of the first and last steps. (See Figure 17.9.) Next, identify the number of steps required for the step carriage using the step calculations identified in the sections on step layout and calculations. In this example, the rise is 124 inches and requires 15 steps (i.e.,  $124 \text{ inches} \div 8 \text{ inches per step} = 15.5 \text{ steps}$ ). Since the arc layout is predicated on using 15 steps, the extra half step needs to be eliminated. To do so, the rise must be reduced by 4 inches, which can be accomplished by adjusting the first or last step center form stakes. In this example, the last step form stake was lowered 4 inches and the trail beyond that point is regraded to compensate.

Next, use pin flags to identify the back corners of the first step. These flags and the previously installed form stake should be perpendicular to the approaching trail. Place a ledger board the length of the desired tread width (5 feet) behind the pin flags and form stake at the first step. Level the ledger board and pin it to the ground with 10-inch spikes. Tie a string line to the center of the first step form stake and extend it up the slope to the point above the form stake marking the last step of the carriage. Place the body of a framing square against the ledger board so the outside of the tongue is at the center of the ledger board and at a right angle to it. Align the

string line along the tongue so it is perpendicular to the center of the ledger board. Once the string line is perpendicular to the first step, drive a form stake (center line form stake) into the ground above the last step and secure the string line to the stake.

Measure from the form stake marking the center of the last step to the string line just installed. Place the body of the framing square against the string line and keep the tape measure along the edge of the tongue to ensure that the tape measure and associated measurement are perpendicular to the string line. In this example, the measurement is 95 inches and represents the amount of arc the step carriage must have to locate the last step where it is desired. Refer to the 15-step column in the chart in Figure 17.9 to identify the depth of the center step that will be required to achieve the 95-inch arc. In this example, the depth of the center step is 15 1/2 inches. Note the arc of the steps does not increase incrementally. The arc becomes more acute as the number of steps increases. The arcs in this chart are approximate but should suffice for the purposes of installing trail steps.

If the arc needed for this carriage exceeds the measurements for 15 steps in this chart (e.g., 108 inches), a tapered landing may be used to increase the arc of the carriage. (See Figure 17.11.) If appropriate to the trail design, the center form stake for the last step can be moved closer so that it is 95 inches from the center string line.

Once the number of steps and the center arc has been identified, the run of the step carriage must be identified. Because the carriage will be curved, the curve must be approximated to identify the run. The exact arc of the step carriage is difficult to identify, however, by using the chart in Figure 17.9 the arc of the carriage can be closely approximated. Using the first, fifth, tenth, and fifteenth step arc measurements from the chart, the arc of the step carriage can be plotted. The locations of the centers of the first and last steps have already been identified and marked with form stakes. To locate the center of the fifth step, multiply the step landing width (15 1/2 inches) by the number of steps (5;  $15 \frac{1}{2} \text{ inches} \times 5 = 77 \frac{1}{2} \text{ inches}$ ). From the center of the ledger board, measure up the string line this distance (77 1/2 inches) and mark the string line with a felt tip marker at that location. Referring to the chart, if the fifth step has a 15 1/2-inch center width taper, the step carriage will have an arc of 7 inches. Next, hold a framing square against the center string line and measure inward along the square (perpendicular to the center string line) 7 inches and place a pin flag at that location. Repeat this process at the tenth step, which, in this example, would be 155 inches up and 39 inches inward of the center string line. Use the step run measuring process identified previously to determine the run of the step carriage along this arc. In this example, the run is 231 inches. (See Figure 17.10.)

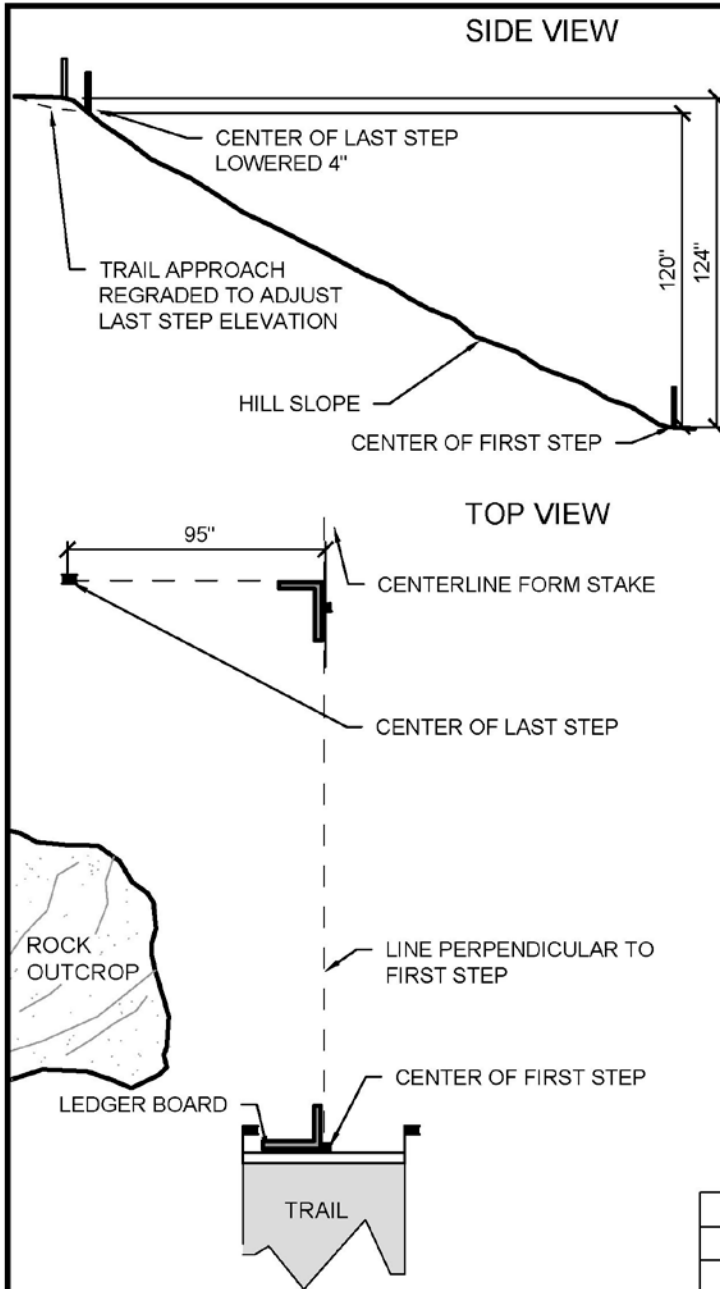

1. PLACE FORM STAKES AT THE STARTING LOCATION (CENTER OF FIRST STEP) AND THE DESIRED ENDING LOCATION (CENTER OF LAST STEP) OF THE STEP CARRIAGE.

2. DETERMINE THE NUMBER OF STEPS BY MEASURING THE RISE BETWEEN THE FIRST AND LAST STEP (124") AND DIVIDING THE BY THE DESIRED STEP HEIGHT (8").  $124"/8"=15\text{-}1/2$  STEPS. SINCE THE THE ARC LAYOUT IS PREDICATED BY THE USE OF WHOLE STEPS THE RISE MUST BE REDUCED BY 4".  $124"-4"=120"$ .  $120"/8"=15$  STEPS. THIS CAN BE ACCOMPLISHED BY ADJUSTING THE FIRST OR LAST STEP CENTER FORM STAKES. IN THIS EXAMPLE THE LAST STEP FORM STAKE WAS LOWERED 4" AND THE TRAIL BEYOND THAT POINT IS REGRADED TO COMPENSATE (DASHED LINES).

3. USE PIN FLAGS TO IDENTIFY THE ENDS OF THE FIRST STEP. THESE FLAGS AND THE PREVIOUSLY PLACED FORM STAKE SHOULD BE PERPENDICULAR TO THE APPROACHING TRAIL. PLACE A 5' LONG LEDGER BOARD BEHIND THE PIN FLAGS AND FORM STAKE OF THE FIRST STEP. LEVEL THE LEDGER BOARD AND PIN IT TO THE GROUND WITH 10" SPIKES. TIE A STRING LINE TO THE FORM STAKE AND RUN IT UP THE HILL SLOPE TO A POINT ABOVE THE FORM STAKE MARKING THE LAST STEP OF THE CARRIAGE. LAY THE BODY OF A FRAMING SQUARE AGAINST THE INSIDE OF THE LEDGER BOARD SO THE TONGUE LINES UP WITH THE CENTER OF THE LEDGER BOARD. ALIGN THE STRING LINE SO IT IS PERPENDICULAR TO THE LEDGER BOARD. ONCE THE STRING LINE IS PERPENDICULAR DRIVE A FORM STAKE (CENTERLINE FORM STAKE) INTO THE GROUND AND SECURE THE STRING LINE TO THE STAKE.

4. MEASURE FROM THE FORM STAKE MARKING THE CENTER OF THE LAST STEP TO THE STRING LINE. PLACE A FRAMING SQUARE AGAINST THE STRING LINE TO ENSURE THAT THE MEASUREMENT IS PERPENDICULAR TO THE STRING LINE. IN THIS EXAMPLE THE MEASUREMENT IS 95". THIS IS THE AMOUNT OF ARC THE STEP CARRIAGE MUST HAVE TO LOCATE THE LAST STEP WHERE IT IS DESIRED. REFER TO THE "APPROXIMATE ARC OF CARRIAGE AT CENTER OF STEPS FIVE FOOT WIDE STEP CHART". REFER TO THE 15 STEP COLUMN AND IDENTIFY THE CENTER DEPTH TREAD TO ACHIEVE THE 95" ARC. IN THIS EXAMPLE THE CENTER STEP DEPTH WOULD BE 15 1/2" .

5. IF THE STEP ARC NEEDED FOR THIS CARRIAGE EXCEEDS THE MEASUREMENTS IN THESE CHARTS (FOR EXAMPLE 108") A TAPERED LANDING MAY BE USED TO INCREASE THE ARC OF THE STEP CARRIAGE (SEE FIGURE 17.11). YOU MAY ALSO REDUCE THE ARC OF THE CARRIAGE BY RELOCATING THE LAST STEP FORM STAKE SO IT IS 95" FROM THE CENTER STRING LINE. IF THIS FORM STAKE IS MOVED YOU MUST KEEP IT AT THE SAME ELEVATION AS ITS PREVIOUS LOCATION OR YOU WILL NEED TO RECALCULATE THE NUMBER OF STEPS REQUIRED.

APPROXIMATE ARC OF CARRIAGE AT CENTER OF STEPS														
FIVE FOOT WIDE STEPS														
NUMBER OF STEPS IN CARRIAGE														
CENTER DEPTH	2	3	4	5	6	7	8	9	10	11	12	13	14	15
14"	1/4"	1/2"	1"	2"	3"	5 1/2"	7"	9 1/2"	12"	15"	18"	22"	25"	28"
14-1/2"	3/8"	1"	2 1/2"	4"	6"	9"	13"	18"	22"	27"	32"	37"	44"	51"
15"	1/2"	1 1/2"	3"	5"	8"	14"	20"	25"	32"	39"	46"	56"	65"	75"
15-1/2"	1"	2"	4"	7"	11"	16"	24"	31"	39"	47"	58"	69"	83"	95"
FOUR FOOT WIDE STEPS														
14"	1/4"	3/4"	2"	4"	6"	9"	12"	16"	20"	25"	30"	35"	41"	48"
14-1/2"	1/4"	1"	3"	5"	8"	12"	17"	23"	29"	37"	45"	53"	62"	72"
15"	1/2"	1 1/2"	4"	6"	9"	15"	19"	25"	33"	40"	48"	57"	68"	78"
15-1/2"	1/2"	2"	5"	8"	14"	21"	29"	37"	48"	59"	71"	85"	98"	115"

Figure 17.9 - Curve Step Layout



CURVE STEP LAYOUT  
CALIFORNIA STATE PARKS

NOT TO SCALE

To determine the average center depth of each step tread, subtract one step from the total number of steps (e.g.,  $15 - 1 = 14$  steps). Then, divide the run by the 14 steps (e.g.,  $231 \text{ inches} \div 14 \text{ steps} = 16 \frac{1}{2} \text{ inches per step tread}$ ). Since the curved step carriage layout requires  $15 \frac{1}{2}$ -inch center treads, the run must be shortened. To determine how much to reduce the run, multiply the prescribed landing width by the number of steps (e.g.,  $15 \frac{1}{2} \text{ inches} \times 14 \text{ steps} = 217 \text{ inches}$ ). Subtract the actual run from the desired run to determine the difference (e.g.,  $231 \text{ inches} - 217 \text{ inches} = 14 \text{ inches}$ ). In this example, the run of the step carriage must be reduced by 14 inches. To reduce the run, move the center of the first step form stake into the hillslope by the necessary amount (e.g., 14 inches), which will require excavation into the hillslope. It is important that the new location of the form stake be kept at its original elevation so the rise of the carriage remains the same. (See Figure 17.10.)

Install the first step (4 inches x 10 inches x 5 feet) at the start of the carriage. The second step is installed with its front inside corner being 13 inches from the front inside corner of the first step, and the front outside corner being 18 inches from the front outside corner of the first step. The center of the tread should be  $15 \frac{1}{2}$  inches from the front of the first step. Remember that the top of the step is part of the tread. Continue this step installation layout until the last step is installed. This layout is the maximum arc that can be achieved while staying within the 13-inch minimum and 18-inch maximum step width. (See Figure 17.11.)

To achieve a more acute curve to the step carriage, a tapered landing is used between step carriages. The use of a landing is limited to where there is an appropriate change of grade in the hillslope, as identified in the step calculations. Determine the taper of the step treads (in this example, 13 inches on the inside, 18 inches on the outside, and  $15 \frac{1}{2}$  inches in the center). Identify the number of steps and the average tread depth using the step calculations identified previously. In this example, the rise in segment A is 48 inches (e.g.,  $48 \text{ inches} \div 8 \text{ inches/steps} = 6$  steps). Subtract one step for the upper tread (e.g.,  $6 - 1 = 5$  steps). The run is  $77 \frac{1}{2}$  inches (e.g.,  $77 \frac{1}{2} \text{ inches} \div 5 \text{ steps} = 15.5\text{-inch treads}$ ). If necessary, adjust the starting point of the step carriage inward or outward to achieve an average tread depth of  $15 \frac{1}{2}$  inches. Install the six steps as in Figure 17.11.

At the change in grade, install the landing. The minimum landing width is 36 inches. Thus, the inside of the landing is 36 inches and the outside of the landing is determined by the desired acuteness for the curve of the step carriage. In this example, the outside landing width is 64 inches. The deeper the outside of the landing is the more acute the curve will be. Once the landing is installed, determine the number of steps and average tread depth for segment B. In this example, the rise in segment B is 56 inches (e.g.,  $56 \text{ inches} \div 8 \text{ inches/step} = 7$  steps). Subtract one step for the upper tread (e.g.,  $7 - 1 = 6$  steps). The run is 93 inches (e.g.,  $93 \text{ inches} \div 6 \text{ steps} = 15.5\text{-inch treads}$ ). If necessary, adjust the starting point of the step carriage inward or outward to achieve an average tread depth of  $15 \frac{1}{2}$  inches. Install the seven steps the same as previously described.

TOP VIEW

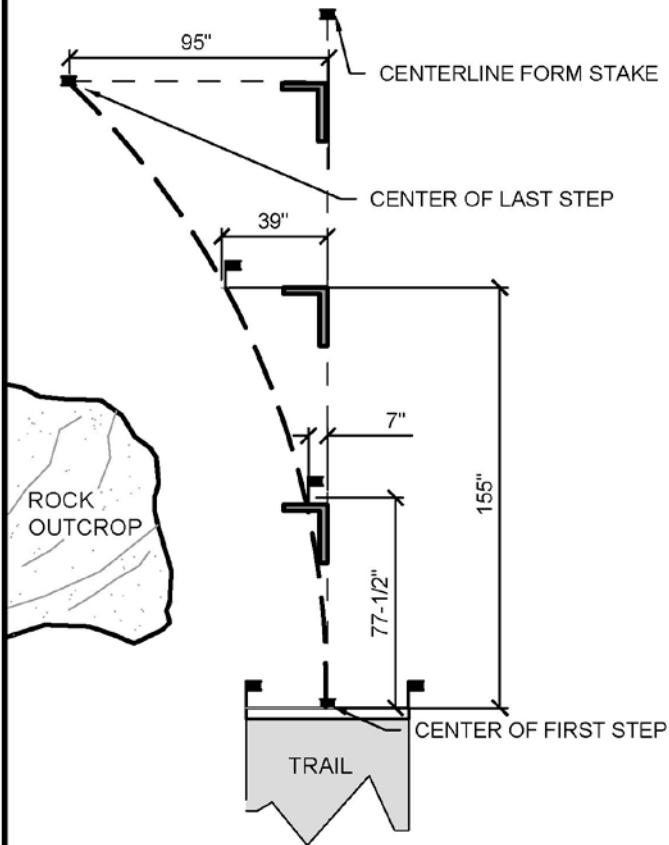

6. DETERMINE THE RUN OF THE STEP CARRIAGE. BECAUSE THE CARRIAGE WILL BE CURVED, THAT CURVE MUST BE APPROXIMATED TO IDENTIFY THE RUN. THE EXACT ARC OF THE STEP CARRIAGE IS DIFFICULT TO IDENTIFY, HOWEVER BY USING THE "APPROXIMATE ARC OF CARRIAGE AT CENTER OF STEPS" TABLE THE ARC OF THE CARRIAGE CAN BE CLOSELY APPROXIMATED. USING THE BEGINNING STEP, 5 STEP, 10 STEP AND 15 STEP ARC MEASUREMENTS FROM THE CHART THE ARC OF THE STEP CARRIAGE CAN BE PLOTTED. THE BEGINNING AND ENDING CENTER OF STEP LOCATIONS HAVE ALREADY BEEN LOCATED AND MARKED WITH FORM STAKES. TO LOCATE THE 5 STEP CENTER STEP LOCATION FIRST MULTIPLY THE STEP TREAD DEPTH (15 1/2") BY THE NUMBER OF STEPS (5), (15 1/2" X 5 = 77 1/2"). FROM THE CENTER OF THE LEDGER BOARD MEASURE UP THE STRING LINE 77 1/2" AND MARK THE STRING LINE WITH A FELT TIP MARKER AT THAT LOCATION. REFERRING TO THE CHART AT 5 STEPS THE 15 1/2" CENTER DEPTH TAPER WILL HAVE AN ARC OF 7". HOLDING A FRAMING SQUARE AGAINST THE CENTER STRING LINE MEASURE INWARD ALONG THE SQUARE (PERPENDICULAR) 7" AND PLACE A PIN FLAG AT THAT LOCATION. REPEAT THIS PROCESS AT THE 10 STEP LOCATION WHICH WOULD BE 155" UP AND 39" INWARD OF THE CENTER STRING LINE. USING THE STEP RUN MEASURING PROCESS. DETERMINE THE RUN OF THE STEP CARRIAGE ALONG THIS ARC BY TAKING HORIZONTAL MEASUREMENTS ALONG THE ARC BETWEEN FLAGS AND FORM STAKES. IN THIS EXAMPLE THE RUN IS 231".

SIDE VIEW

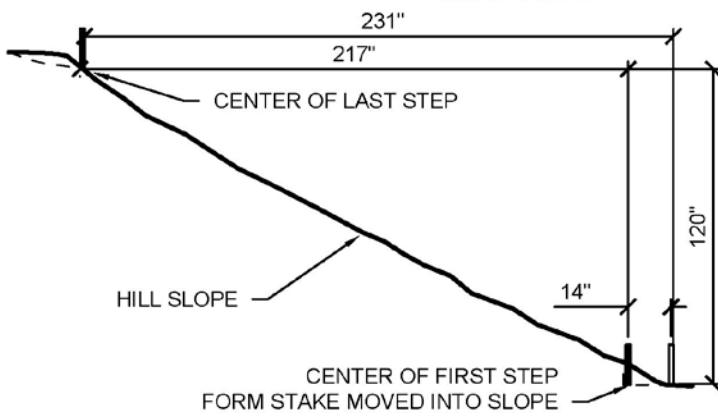

7. DETERMINE THE AVERAGE CENTER DEPTH OF EACH STEP LANDING. SUBTRACT ONE STEP FROM THE TOTAL NUMBER OF STEPS (15 - 1 = 14 STEPS). THEN DIVIDE THE RUN BY THE 14 STEPS (231 / 14 = 16 1/2" STEP TREADS). SINCE THE CURVED STEP CARRIAGE LAYOUT REQUIRES 15 1/2" CENTER OF TREAD DEPTHS THE RUN MUST BE SHORTENED. TO DETERMINE HOW MUCH TO REDUCE THE RUN MULTIPLY THE PRESCRIBED LANDING DEPTH BY THE NUMBER OF STEPS (15 1/2" X 14 = 217"). SUBTRACT 217" FROM 231" (231" - 217" = 14"). THE RUN OF THE STEP CARRIAGE MUST BE REDUCED BY 14". THIS IS ACCOMPLISHED BY MOVING THE CENTER OF THE FIRST STEP FORM STAKE INTO THE HILL SLOPE 14". IT IS IMPORTANT THAT THE NEW LOCATION OF THE FORM STAKE BE KEPT AT ITS PREVIOUS ELEVATION SO THE RISE OF THE CARRIAGE REMAINS THE SAME. THIS WILL REQUIRE ADDITIONAL EXCAVATION INTO THE HILL SLOPE.

Figure 17.10 - Curve Step Layout Continued



CURVE STEP LAYOUT CONTINUED

CALIFORNIA STATE PARKS

NOT TO SCALE

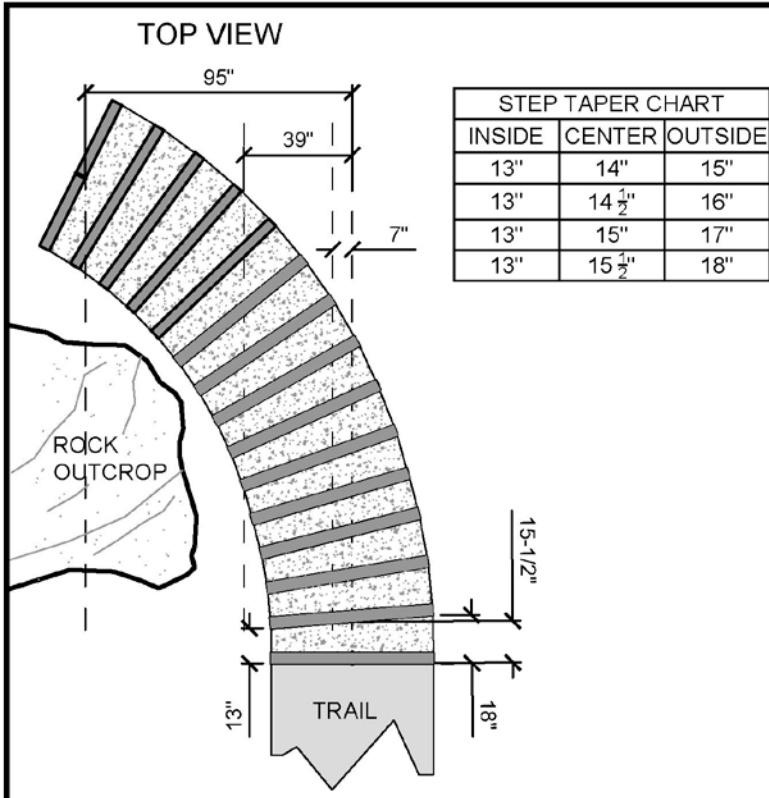

1. INSTALL THE FIRST 4" X 10" X 5' STEP AT THE START OF THE CARRIAGE. THE SECOND STEP IS INSTALLED WITH ITS FRONT INSIDE CORNER BEING 13" FROM THE FRONT INSIDE CORNER OF THE FIRST STEP AND THE FRONT OUTSIDE CORNER BEING 18" FROM THE FRONT OUTSIDE CORNER OF THE FIRST STEP. REFER TO THE STEP TAPER CHART FOR APPROPRIATE INSIDE, CENTER, AND OUTSIDE TREAD DEPTHS. THE CENTER OF THE TREAD SHOULD BE 15 1/2". REMEMBER THAT THE TOP OF THE STEP IS PART OF THE TREAD. CONTINUE THIS STEP INSTALLATION LAYOUT UNTIL THE 15TH AND LAST STEP IS INSTALLED. KEEPING TO THE 13" MINIMUM AND 18" MAXIMUM TREAD DEPTHS, THIS LAYOUT IS THE MAXIMUM ARC THAT CAN BE ACHIEVED. NOTE THAT THE CURVE OF THE STEP CARRIAGE BECOMES MORE ACUTE AS THE NUMBER OF STEPS INCREASES. THIS INCREASE IS NOT INCREMENTAL.

2. TO ACHIEVE A MORE ACUTE CURVE TO THE STEP CARRIAGE A TAPERED LANDING IS USED. THE USE OF THE LANDING IS LIMITED TO A LOCATION WHERE THERE IS AN APPROPRIATE CHANGE OF GRADE IN THE HILLSLOPE AS IDENTIFIED IN THE STEP CALCULATIONS PROCESS. USE THE CURVE STEP LAYOUT PROCESS PREVIOUSLY DESCRIBED TO LAYOUT THE FIRST STEP CARRIAGE (SEGMENT A). IN THIS EXAMPLE THE RISE IN SEGMENTS A IS 48". (48/8 = 6 STEPS) AND THE RUN IS 77 1/2" (77-1/2"/5 = 15-1/2" TREADS). IF NECESSARY, ADJUST THE STARTING POINT OF THE STEPS INWARD OR OUTWARD TO ACHIEVE AN AVERAGE TREAD DEPTH OF 15 1/2". DETERMINE THE TAPER OF THE STEP TREAD DEPTH. IN THIS EXAMPLE 13" ON THE INSIDE AND 18" ON THE OUTSIDE OF THE TREAD. INSTALL THE 6 STEPS AS PREVIOUSLY DESCRIBED.

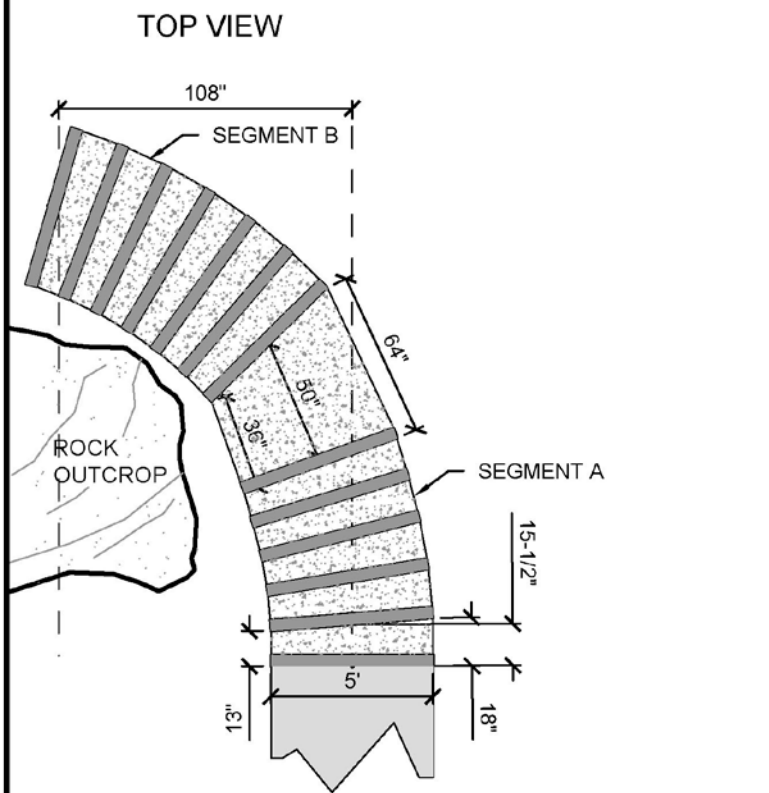

3. AT THE CHANGE IN GRADE INSTALL THE LANDING. THE MINIMUM LANDING DEPTH IS 36". THE INSIDE OF THE LANDING IS 36". THE OUTSIDE OF THE LANDING IS DETERMINED BY HOW ACUTE YOU WANT THE CURVE OF THE STEP CARRIAGE TO BE. IN THIS EXAMPLE IT IS 64". THE LONGER THE OUTSIDE OF THE LANDING DEPTH IS THE MORE ACUTE IT WILL BE. ONCE THE LANDING IS INSTALLED USE THE CURVE STEP LAYOUT PROCESS PREVIOUSLY DESCRIBED TO LAYOUT THE SECOND STEP CARRIAGE (SEGMENT B). IN THIS EXAMPLE THE RISE IN SEGMENTS B IS 56". (56/8 = 7 STEPS) AND THE RUN IS 93" (93/6 = 15.5" TREADS). IF NECESSARY, ADJUST THE STARTING POINT OF THE STEPS INWARD OR OUTWARD TO ACHIEVE AN AVERAGE TREAD DEPTH OF 15 1/2". DETERMINE THE TAPER OF THE STEP TREAD DEPTH. IN THIS EXAMPLE 13" ON THE INSIDE AND 18" ON THE OUTSIDE OF THE TREAD. INSTALL THE 7 STEPS AS PREVIOUSLY DESCRIBED.

**Figure 17.11 - Curve Step Construction**



**CURVE STEP CONSTRUCTION**

CALIFORNIA STATE PARKS

NOT TO SCALE

### 17.4.3. Rock Steps

Rock steps are aesthetically pleasing in the appropriate locations and last longer than wooden steps. (See Photo 17.3.) However, even when the trail traverses rocky outcroppings, suitable rock may not be readily available. The additional effort to select, quarry, and transport rock is often justified by its structural durability and aesthetic qualities. Searching some distance from the trail for suitable rock material may be necessary. In other cases, rock may be partially buried under duff and litter and require some excavation. Use of native materials must be disclosed in the project's environmental documents and receive prior evaluation and approval. (See Chapter 20, *Materials*.) If economics, logistics, or resource protection issues prohibit gathering or quarrying local rock, then purchasing and importing rock may be the only option.



**Photo 17.3 - Rock Steps**

Rocks for step material should weigh between 200 and 300 pounds for pedestrian trails and 300 to 500 pounds for equestrian trails. Larger rocks can be used, but require greater effort to move and place. Additional time and increased safety risks exist if rock is not moved properly. Rigging such as skylines can be employed to move rock, which increases the size that can be used safely and efficiently. Smaller rocks lack the mass needed to achieve the desired stability and durability. Ideally, rock for pedestrian steps should be large enough to provide stability but small enough that a single worker can move them by pissing (rolling or maneuvering rock without lifting) or using a rock bar.

Rock must also have the proper shape and dimensions. Individual rock steps set in the ground must have at least one flat surface to serve as a tread and one 90-degree face from that surface to serve as the front of the step. Rocks used in an

overlapping rock step design must have two flat sides - one for contact with the rock below and one to serve as the tread and provide good contact with the rock above. Rock used in steps must also have a thickness consistent with the desired rise of each step.

#### 17.4.4. Rock and Riser Steps

Rock and riser steps are individual rock steps that are not structurally connected. They are a good design for stable slopes with low to moderate user traffic. (See Figure 17.12.)

As with wooden steps, installation begins at the bottom of the carriage. The first step is the keystone that buttresses the entire carriage. This step is well-anchored and has the mass to support the steps above it. Before placing the rock, a footing is excavated so that approximately one-third of the mass of the rock is below grade and tilted into the hillslope by approximately 5%. The rock lies back into the hillslope and produces an inward and downward force, rather than outward and downward. The excavation must match the bottom of the rock so it sits snugly in the ground. Be careful not to over excavate the footing because backfill will then be required to bring the footing to the proper grade. If backfill is required to adjust the elevation of the footing or fill voids, use well compacted aggregate to prevent settling. Once placed into the footing, the rock must have the required rise above the approaching trail tread. The top of the step must be level from front to back or tilted slightly backwards by approximately 5%. If a cross slope is required for drainage, the rock is set to have the appropriate cross slope. (See Figure 17.12.) Additional steps are installed in the same manner.

The excavation for the next step is such that once the second step is placed, the top of the rock is the required rise above the first rock step and the front of the rock is the required distance from the front of the first step rock (i.e., provides the required tread depth). If more than one rock is required to construct a step, there must be good contact between the adjoining rock faces. At a minimum, the two rocks must have good contact at the top and rear of adjoining rock faces so the rocks will not roll forward when weight or force is applied to the top front edge of the step. (See Figure 17.12.) Additionally, the face of the rocks should not overhang the lower steps. The overhang provides leverage for displacing the rock if the front of the overhanging rock is stepped on. Continue the carriage construction in the same manner, making certain that the rise and run are the same for each step, and that the bottom of the top step is set below the top of the lower step.



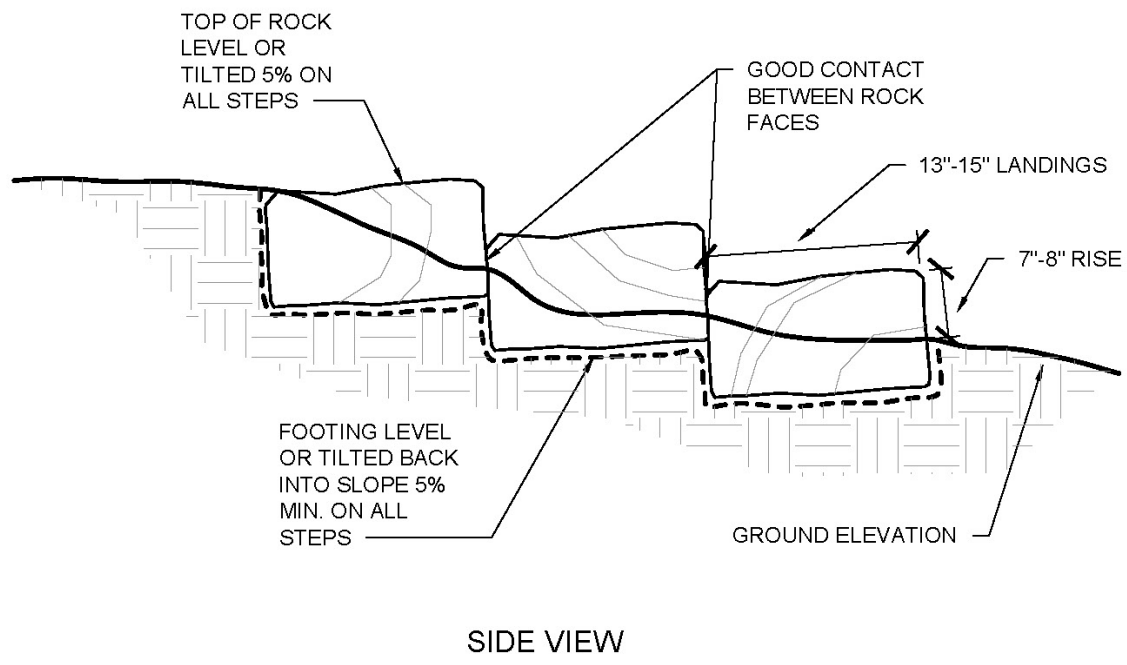
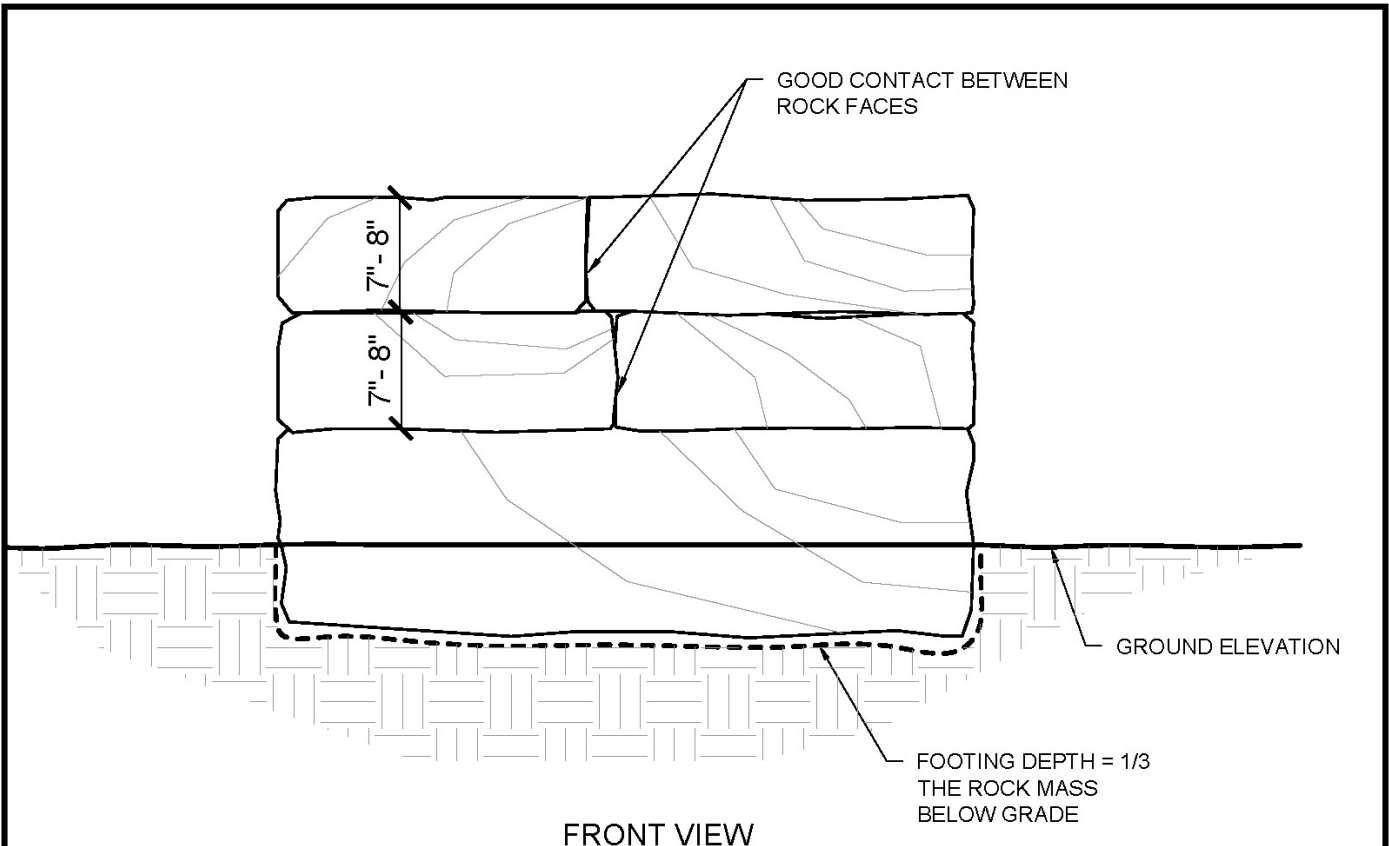

**Figure 17.12 - Rock and Riser Steps**



**ROCK AND RISER STEPS**  
**CALIFORNIA STATE PARKS**

NOT TO SCALE

#### 17.4.5. Rock Framed Steps

Rock framed steps are a good design on steep or unstable slopes where additional structural support is necessary. (See Photo 17.4.) They are also a good design for high-use pedestrian and equestrian trails due to their structural integrity. (See Figure 17.13.) Rock framed steps are a variation of rock riser steps. In addition to the rocks that serve as risers and treads, wall rocks are installed on both sides of the step to help lock it into the hillslope. The wall rocks are placed in an excavated footing that accommodates the size of the rock, starting at the bottom of the carriage and simultaneous to placement of the step rocks. The bottom wall rocks are placed on both sides of the step rocks and serve as keystones for the wall rock above. Therefore, the mass of the bottom wall rocks must be large enough to perform this function. Wall rocks are wedged tightly into the trench using rock wedges to fill voids and increase contact (“chinking”). Good contact between the upper and lower wall rocks and the step rock is critical to provide the friction that locks these stones into place. As in dry stone construction, all joints are broken and good contact is made between all rocks. (See Figure 17.13.)



**Photo 17.4 - Rock Framed Steps**

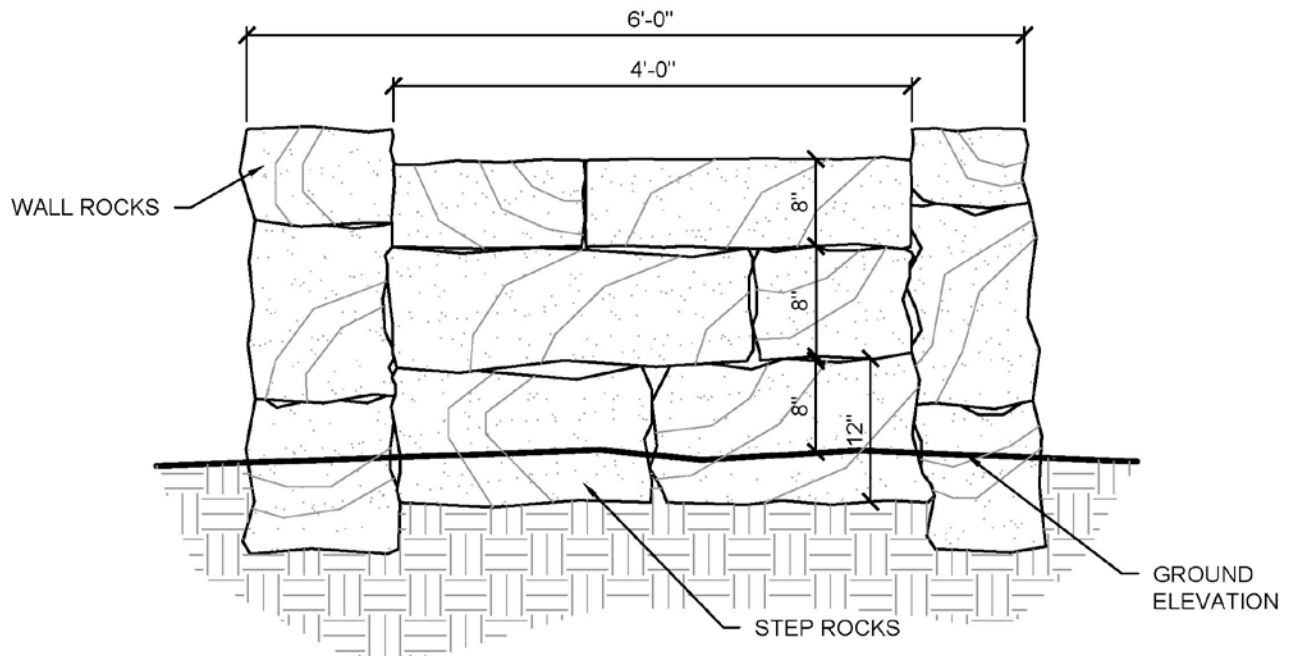

FRONT VIEW

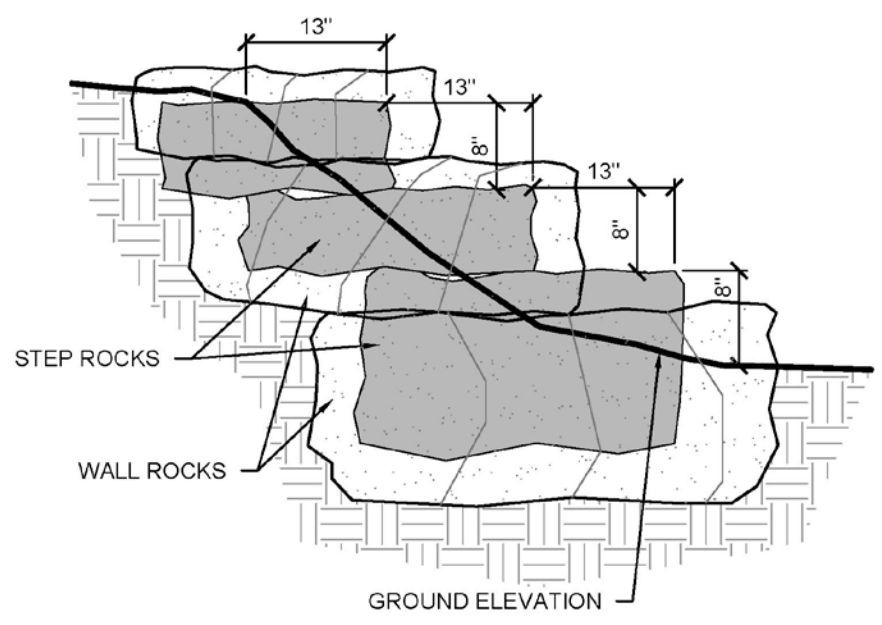

SIDE VIEW

Figure 17.13 - Rock Framed Steps



ROCK FRAMED STEPS  
CALIFORNIA STATE PARKS

NOT TO SCALE

#### 17.4.6. Overlapping Rock Steps

Overlapping rock steps are a good design for stable slopes with low to moderate pedestrian traffic. (See Figure 17.14.) Overlapping rock steps are installed in a similar manner to rock riser steps, but instead of being placed independently, the steps are interlocked with the front of the top step over the back of the bottom step. The overlap of the two steps should be a minimum of 25% of the depth of the step tread. Contact between the two rock surfaces must be sufficient to fully support the upper step. Uneven contact can lead to slippage, rocking, or fracturing of the upper step rock, which can create both a safety and a sustainability problem.

This style of step requires rocks that have adequate thickness for the designed rise and are rectangular and uniformly shaped for good contact. The top of the rock needs a relatively flat and uniform surface, especially toward the back where the next step is to rest on top of it. The bottom of the rock needs to have a flat and uniform surface toward the front of the rock where it overlaps with the rock below it. Although a rock with uniform rectangular shape works well for this purpose, rocks that are thicker at the rear bottom half are more desirable as they add more mass to the back of the step and anchor it better into the hillslope. (See Figure 17.14.)

#### 17.4.7. Equestrian Steps

For an equestrian trail, it is best to avoid steep linear grades or other situations where steps will be required. Although horses are capable of traversing steps, many prefer not to use them. When determined to be necessary, equestrian steps should follow the same layout procedures as for wooden or rock steps, except the step treads must be 48 inches deep. The extra depth allows a horse to have at least half of its body on a step at a time. This spacing also accommodates the gait of horses and minimizes tripping and stumbling while ascending or descending. (See Figure 17.15.) Transition landings must be 96 inches deep so a horse can have its entire body on the landing. The step width on equestrian trails should be a minimum of 48 inches with 60 inches being the optimal width.

Additional requirements for construction of equestrian steps include the use of erosion-resistant backfill material and the placement of barriers along the trail edge. Hooves scuff and scrape soft soil creating depressions or ruts behind the steps. If steps are backfilled with erosion-resistant materials, such as crushed rock, shale, or a mixture of soil and rock, durability is greatly improved. As with all steps, the tread is sloped in or out slightly for drainage, and a rock-lined ditch may be necessary to carry water off the trail. To prevent stock from walking around the steps, barriers of rocks or logs are placed on the both sides of the carriage in a manner that does not impede drainage flow. The barriers should be imposing to discourage stock from venturing off the step section or travelway.

FRONT VIEW

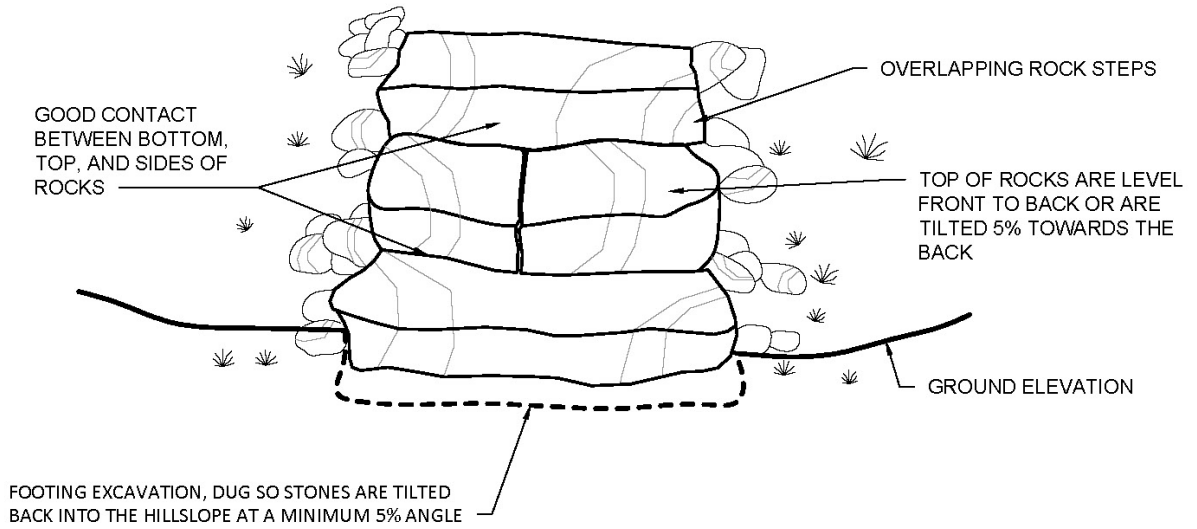

ISOMETRIC VIEW

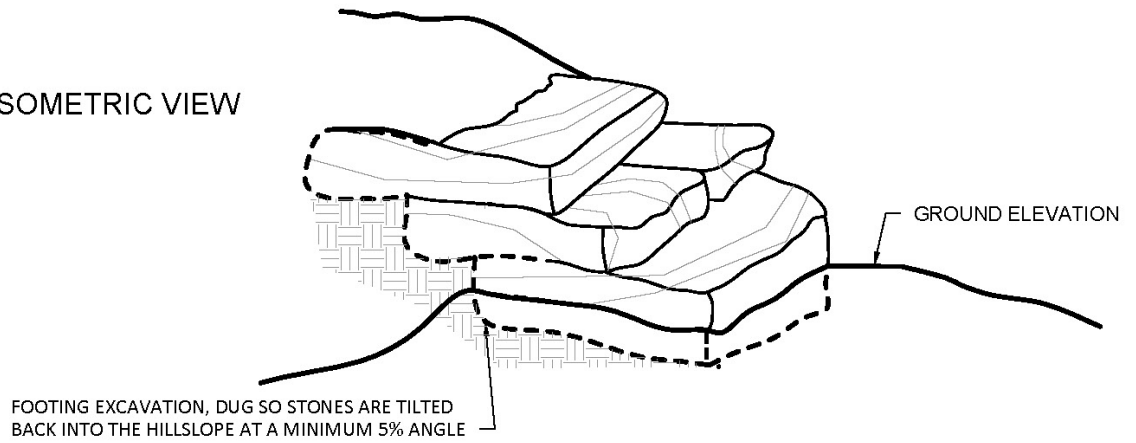

Figure 17.14 - Overlapping Rock Steps



OVERLAPPING ROCK STEPS

CALIFORNIA STATE PARKS

NOT TO SCALE

FRONT VIEW

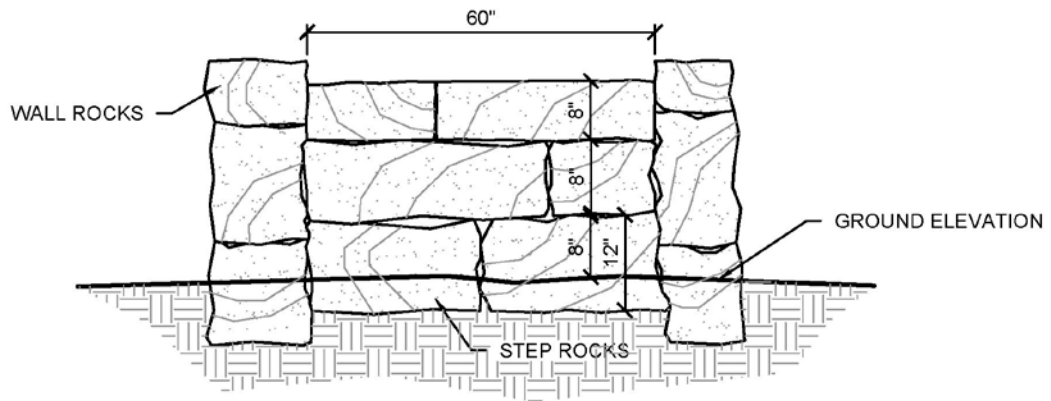

SECTION VIEW

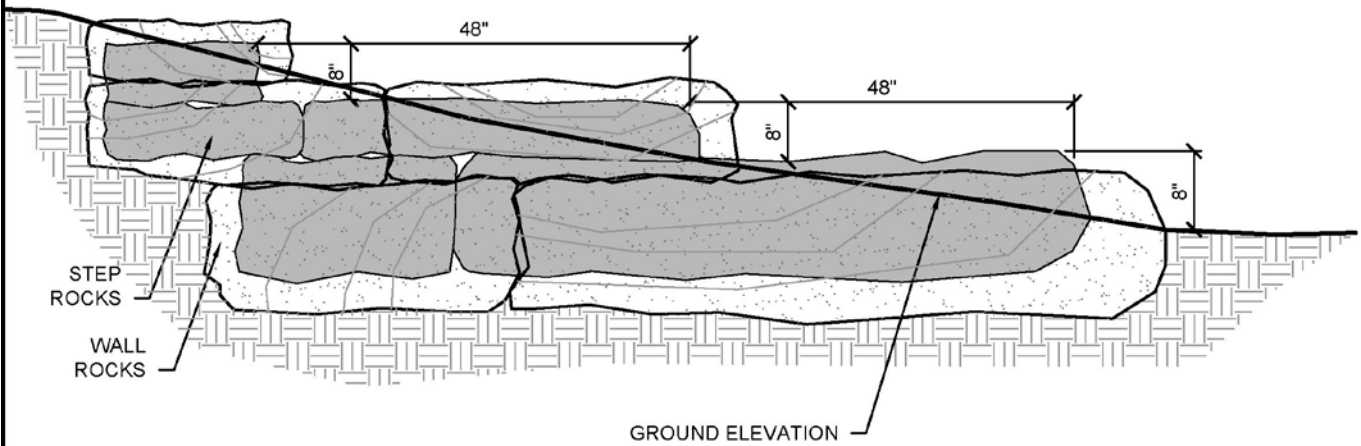

Figure 17.15 - Equestrian Steps



EQUESTRIAN STEPS  
CALIFORNIA STATE PARKS

NOT TO SCALE

#### 17.4.8. Interlocking and Cribbed Steps

Ordinary wooden steps may be unsuitable at some sites. The ground may be full of large rocks or roots, making excavation impossible, or the site may be too steep to allow for installation of steps with 13-inch treads. In these cases, partial or full cribbed steps are a solution. They are also a good design for pedestrian and equestrian high-use trails due to the structural integrity.

##### 17.4.8.1. Interlocking Steps

Partial cribbed steps, called interlocking steps, are built with an additional cribbed wall or walls that frame the step tread. (See Figure 17.16 and Photo 17.5.) When the step carriage traverses the hillslope at an oblique angle, the steps require a cribbed wall on the outside of the trail. In a carriage, the steps are interlocked as the cribbed wall is notched and pinned to both the bottom step and step above it. The notch depth is half the 8-inch height of the step and 8-inch height of the cribbed member (full dimension lumber). When notched in this manner, the cribbed wall is flush with the top of the step below and with the bottom of the step above. A 9/16-inch hole is drilled through the center of the notch and the steps and cribbed wall are secured with a 5/8-inch piece of rebar. (See Figure 17.16.)



**Photo 17.5 - Single Interlocking Steps**

When the step carriage traverses straight up the hillslope, it requires a cribbed wall on both sides of the steps (double interlocking steps). (See Photo 17.6.) The inside cribbed wall is installed in the same manner as the outside cribbed

wall to provide additional structural support to the carriage and help contain the material used for the tread. (See Figure 17.17.)



**Photo 17.6 - Double Interlocking Steps**

#### 17.4.8.1. Full Cribbed Steps

Some situations call for a more complex structure, such as full cribbed steps. (See Figure 17.18 and Photo 17.7.)



**Photo 17.7 - Wooden Cribbed Steps**



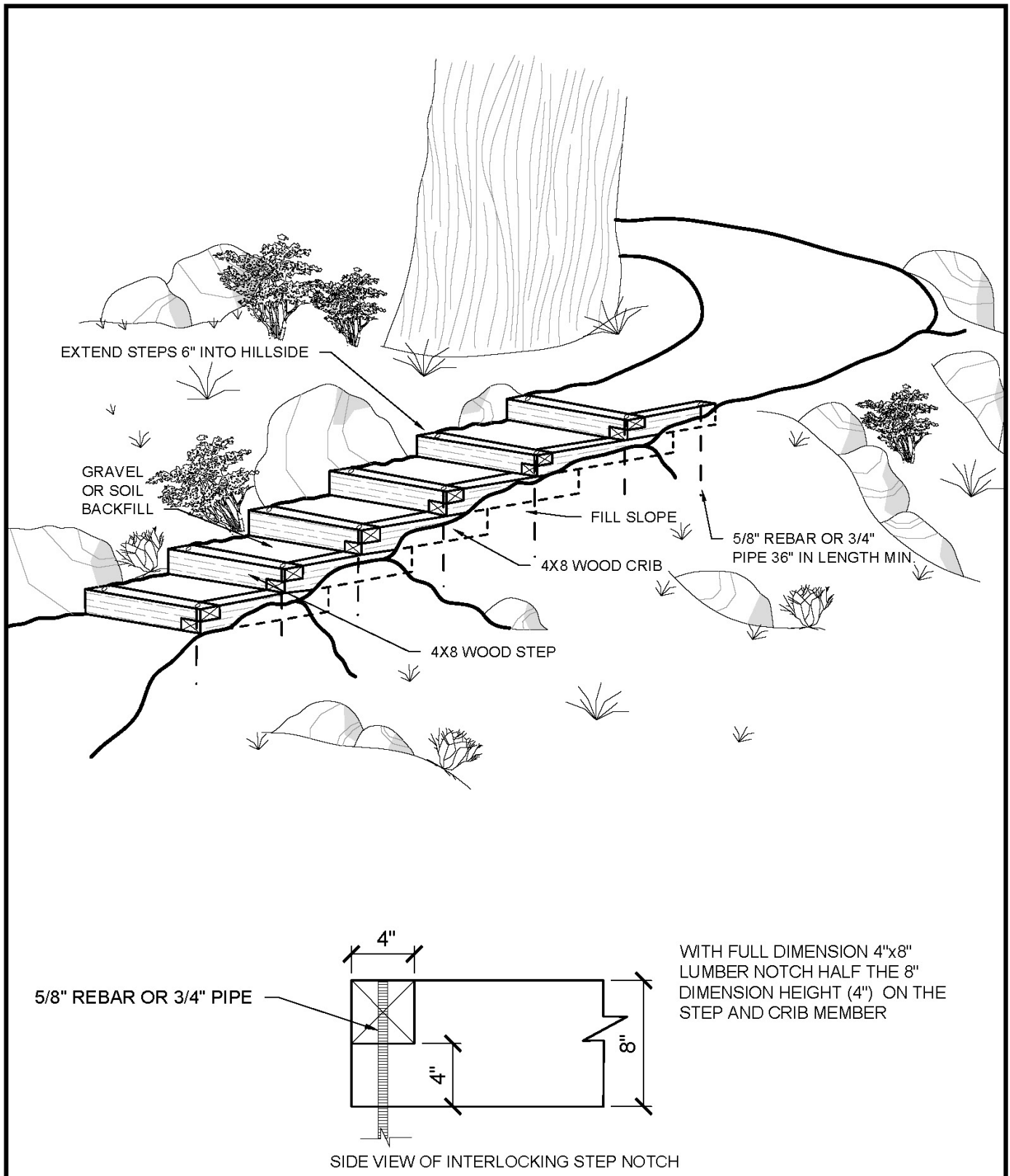
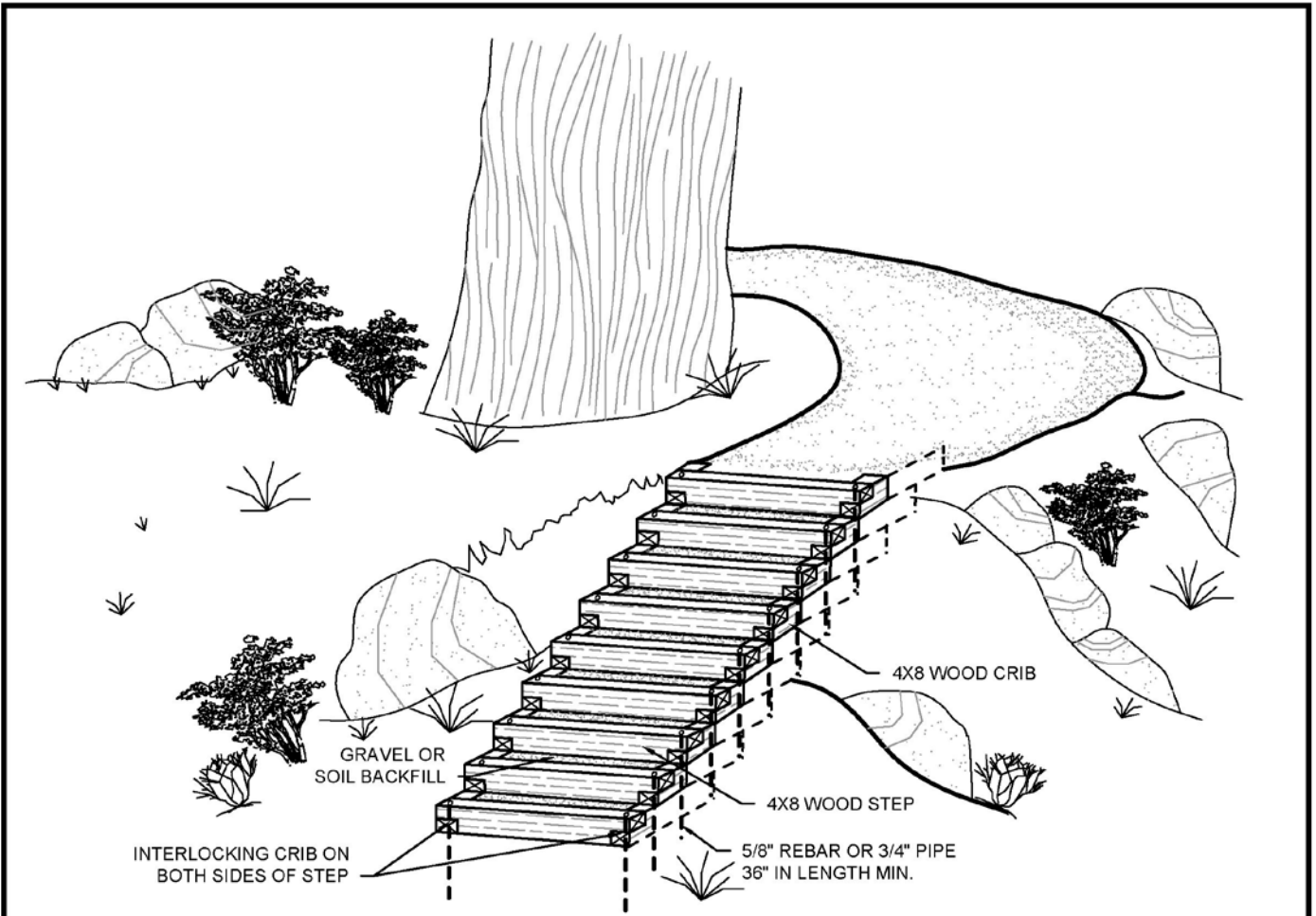

**Figure 17.16 - Interlocking Steps**



**INTERLOCKING STEPS**  
**CALIFORNIA STATE PARKS**

NOT TO SCALE



INTERLOCKING CRIB ON BOTH SIDES OF STEP

GRAVEL OR SOIL BACKFILL

4X8 WOOD CRIB

4X8 WOOD STEP

5/8" REBAR OR 3/4" PIPE  
36" IN LENGTH MIN.

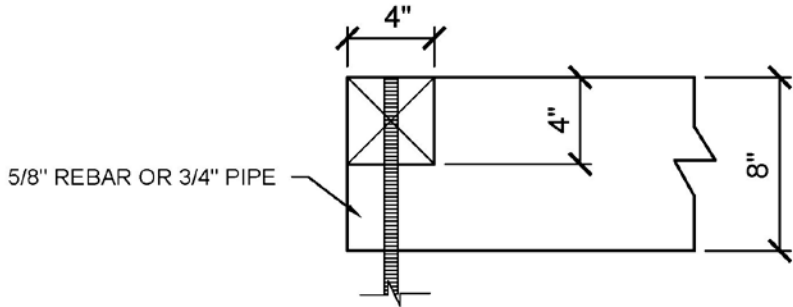

5/8" REBAR OR 3/4" PIPE

WITH FULL DIMENSION 4"x8" LUMBER NOTCH HALF THE 8" DIMENSION HEIGHT (4") ON THE STEP AND CRIB MEMBER

SIDE VIEW OF INTERLOCKING STEP NOTCH

**Figure 17.17 - Double Interlocking Steps**



DOUBLE INTERLOCKING STEPS  
CALIFORNIA STATE PARKS

NOT TO SCALE

There are four common reasons for full cribbed steps.

- **Grade Too Steep:** A hillslope that cannot be cut for fear of erosion can require full cribbed steps. The step carriage is built as a freestanding box into the side of the hillslope. This structure protects the hillslope and provides trail users with a safe and sustainable way of traversing the slope.
- **Grade Not Steep Enough:** In some cases, visitor safety or resource protection require steps in an area of less than 40% grade. A step with an 8-inch rise and an 18-inch run has a 44% grade. To construct steps in an area with less than a 44% grade, excavate into the hillside at 10% or less grade until the run is shortened enough to provide a minimum 44% grade. If it is not possible to achieve this grade, full cribbed steps are used to elevate the structure above the natural grade. When the steps reach the same elevation as the upper trail grade, the top section is extended on a level plane until it intersects with the upper trail.
- **Large Obstructions:** If the trail must pass over a large obstruction such as a boulder, full cribbed steps are used. The steps are built as a freestanding box and backfilled.
- **Extremely Steep or Unstable Sidehill:** When the trail passes through an area where a full cribbed retaining wall is necessary to hold the tread, steps are built into the top of the wall. In this case, the steps function as exposed anchor post. This application also incorporates aspects of the first three applications, with the difference being that this step section is built into the hillside as opposed to being a freestanding box.

Full cribbed steps are constructed with milled redwood or cedar, pressure treated lumber, or structural plastic lumber. The step material needs to be 4- x 8-inch stock. The length of the cribbed wall stock is dictated by the height of the carriage and the site where it will be constructed. The length of the steps and anchor post members need to be no less than 18 inches longer than the desired step tread width. The additional length is required for the 4-inch width of the notch on the cribbed wall (full dimension lumber) and the 5-inch overhang on the outside of the cribbed walls. (See Figure 17.18)

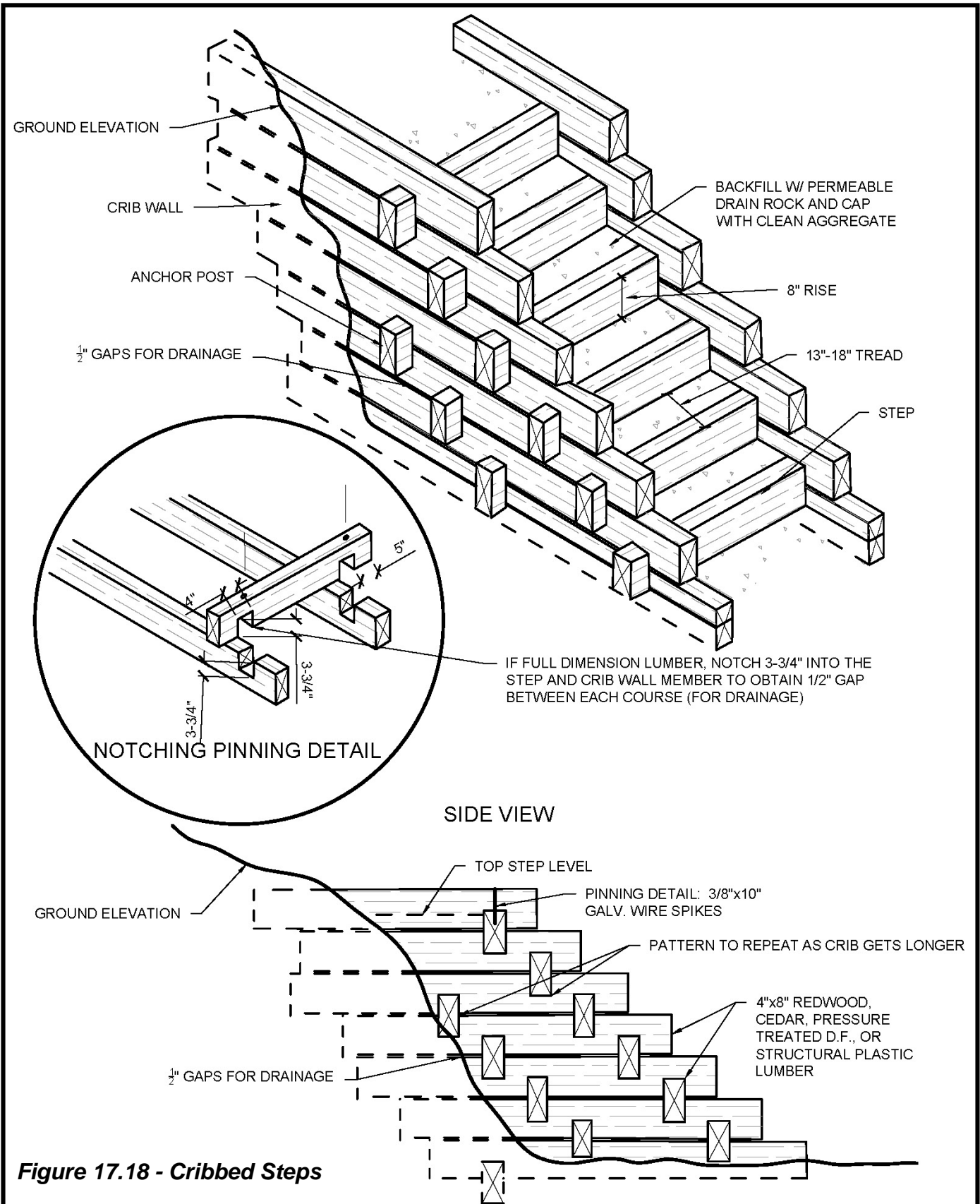

**Figure 17.18 - Cribbed Steps**



**CRIBBED STEPS**  
CALIFORNIA STATE PARKS

NOT TO SCALE

A full cribbed step is a retaining structure with steps and its construction is similar to a wooden cribbed abutment. The two outside cribbed walls are unitized (connected) by steps and anchor posts. The step member spans between the two cribbed walls and serves the function of the step riser as well as a facer. The anchor post also spans between the two cribbed walls (further into the structure, behind the steps). It ties the two cribbed walls together and provides additional rigidity and structural integrity to the carriage. The steps and anchor posts are notched into the cribbed walls.

Both the step/anchor post and the cribbed wall are notched to a depth of 3 3/4 inches (with full dimension lumber) so that when the two members are seated together a 1/2-inch gap remains between the cribbed wall members. Fill material placed inside the cribbed walls consists of 2- to 3-inch washed drain rock. The gap between the cribbed wall members is to allow surface drainage to flow freely through the drain rock and out of the structure. This notching pattern also results in the step being evenly spaced between two outside cribbed walls. This spacing is required so the cribbed wall frames in the step tread and retains the step backfill material. (See Figure 17.18.)

#### 17.4.9. Cable Steps

Cable steps are a series of steps strung together with galvanized wire rope. (See Photo 17.8.) They are draped over the surface of highly unstable material such as sand, or seasonally eroded surfaces such as ocean bluffs exposed to storm waves. (See Figure 17.19.) This step design is only used for pedestrian trails.



**Photo 17.8 - Cable Steps**

Even though the step material has a 6- x 6-inch dimension, use an 8-inch rise per step when determining the number of steps and the depth of the treads. The 8-inch rise between steps is achieved by increasing the fill material behind the step so the

back of the step is 2 inches higher than the front of the tread. Once the layout has been determined, “dead man anchors” are installed a minimum of 18 inches into the ground at each end of the step carriage. These anchors are 6- x 6-inch timbers cut to the same length as the steps. Drill holes through the center of the dead man timbers 3 inches from each end. Two galvanized wire ropes 3/8 inch in diameter are then passed through each hole on the upper anchor, wrapped half way around the timber and then secured with 3/8-inch wire rope clips. (See Figure 17.19.) The two galvanized wires are then draped down the hillslope.

The cable step material is made from 6- x 6-inch construction heart redwood or cedar, with the edges cut at a 45 degree angle for an even-sided octagon. A table saw with a fence and a ripping blade set at a 45 degree angle is used to create the octagon shaped steps. The octagon shaped step is used to provide increased traction for the user. Round peeler core timbers used for this purpose do not provide adequate traction and can be slippery. Drill 1/2-inch diameter holes through the center of each step 3 inches from each end. (See Figure 17.19.)

Where the step carriage will be constructed, the required number of steps should be laid out on the hillslope. Pass the ends of the galvanized wire rope through the holes in the steps. Leave enough space on the ground and slack in the wire rope to make adjustments. Note, when the wire rope is cut to length for this carriage, braze or wrap duct tape around the cut ends to prevent unraveling and make it easier to pass through the holes in the steps. Using the previously determined tread depth, slide the top step up the wire rope to the appropriate distance from the top anchor. Adjust the underlying ground to achieve a roughly shaped tread. Once the step has the required rise and tread depth, secure it in place by attaching a wire rope clip to the wire rope where it exits the underside of the step. The clip will keep the step from sliding further down the wire rope. Install the remaining steps following this process working from the top step down. Maintaining some downward tension on the wire ropes as steps are set will also maintain stability and minimize settling when backfilling. (See Figure 17.19.)

Some locations require importing material suitable for placement beneath the step carriage, so that a reasonable rise and run are obtained. If the parent material is sand, sand bags will help support the structure.

Once all the steps have been installed, the remaining wire rope is passed through the holes in the bottom anchor and secured in the same manner as the top anchor.

Over time the native material underneath the steps moves or erodes. To compensate for this movement, the wire rope clips are loosened and the steps and underlying material are returned to the original layout. When cable steps are used where winter waves can dash against them, disconnect the carriage from the bottom anchor and roll the steps up so they are out of the wave slope. Later, the steps can be rolled back down the slope, reset, and reattached to the bottom anchor. The

galvanized wire rope must be regularly inspected for broken strands that compromise the strength of the carriage and create burrs that could injure trail users.

#### 17.4.10. Cutout Stringer Stairways

To provide adequate clearance above high water flows, many bridges are constructed with cribbed abutments. These abutments result in a significant elevation difference between the trail grade and the bridge deck or tread. One method of access from the trail grade to the bridge tread is a stairway. (See Figure 17.20.)

The most common stairway design is the cutout stringer stairway. (See Photo 17.9.) Layout and calculations for this structure are similar to other step structures. First measure the distance from the top of the bridge decking to the trail grade to determine the rise. The run is the distance from the bridge stringer to where the step carriage will rest on a mudsill. (See Figure 17.20.)



**Photo 17.9 - Cutout Stringer Stairway**

Calculations for a stringer stairway are done in the same manner as for the wooden and rock step carriages, with a few differences. The total rise is measured and divided by 8 inches, the height of each step. For example, if the rise is 96 inches, the structure will require 12 steps ( $96 \div 8 = 12$ ). To determine the required number of treads, subtract one from the total number of steps since the last step is on the bridge deck and has no tread. If 12 steps are required, there will be 11 treads ( $12 - 1 = 11$ ).

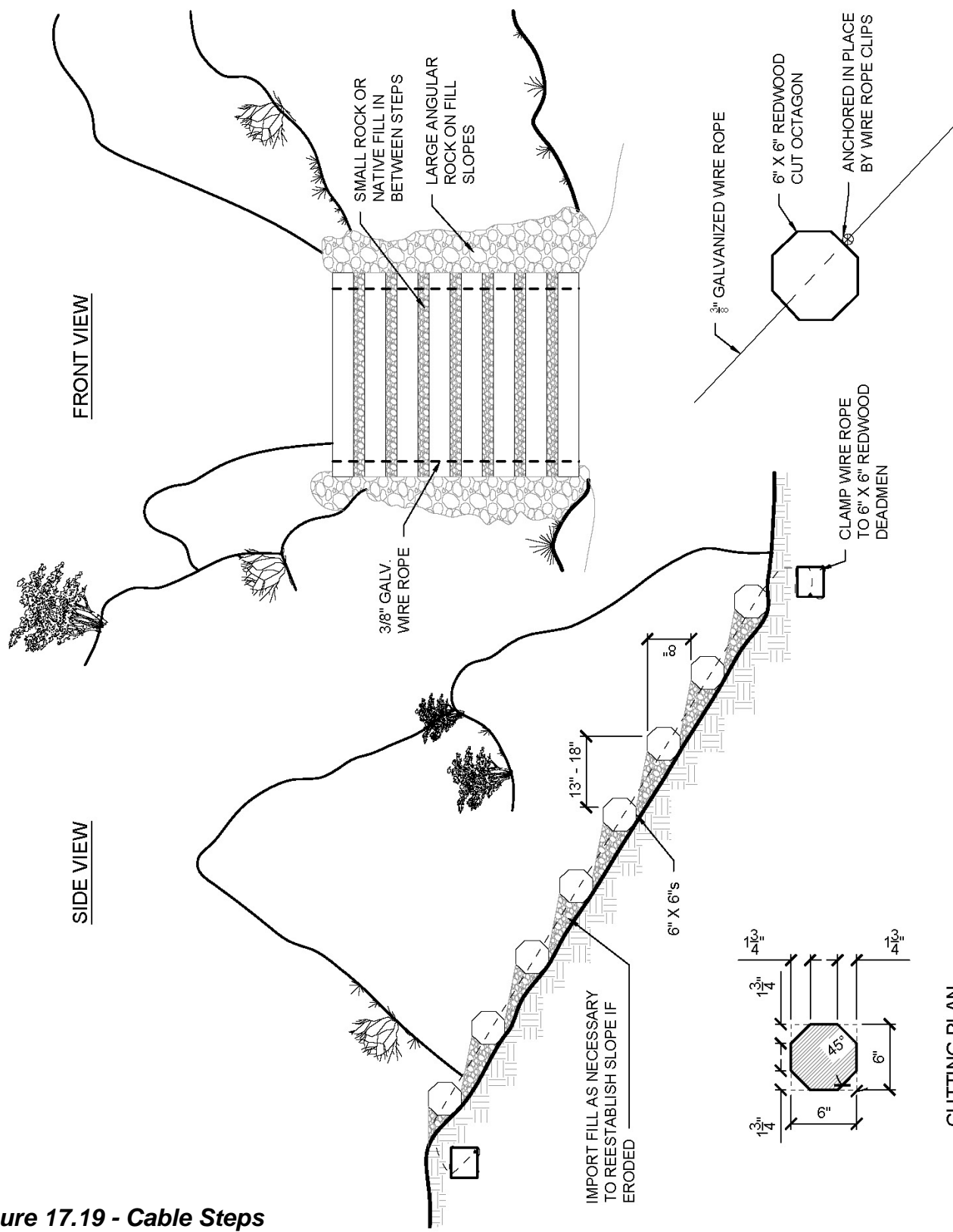

Figure 17.19 - Cable Steps



**CABLE STEPS**  
CALIFORNIA STATE PARKS

NOT TO SCALE



To determine the required run, first identify the desired tread depth. Then, multiply the desired tread depth by the number of treads to determine the total run. For example, if there will be 11 treads that are 13 inches deep, the total run will be 143 inches (13 inches per tread x 11 treads = 143 inches). If toe plates (vertical boards between each step) are to be installed, increase the tread depth by the thickness of the toe plate board. For example, if the toe plate board is 2 inches thick, the tread depth needs to be increased by 2 inches to a total depth of 15 inches. The run will now be 165 inches (15 inches per tread x 11 treads = 165 inches).

Use the total run to determine where the step carriage will start. A plumb bob hung from the end of the stringer will help locate where the end of the bridge stringers are on the ground. Measure the horizontal run from this location. Mark the location where the run ends with a form stake or pin flag. This location is where the mudsill will be constructed upon which the step carriage will set.

To determine the step stringer length, measure diagonally from the top edge of the bridge stringer to the step stringer attachment point at the front top of the mudsill. Add 16 to 18 inches to ensure there is enough material for the step stringer. Step stringers are constructed from construction grade con heart redwood, construction grade cedar, or pressure treated Douglas fir with minimum dimensions of 6 x 14 inches.

The layout for cutting out the step stringers is performed with a steel framing square. (See Figure 17.20.) The body or large end of the square is placed on the side of the step stringer and moved up and down until the 13-inch mark is at the top edge of the step stringer (15 inches if a 2-inch thick toe plate is installed). The tongue or small end of the square is then moved until the 8-inch mark is on the top edge of the step stringer. Once the square is placed in this manner, lines are scribed along the outer edges of the body and tongue of the square until they meet at the heel of the square. The tongue represents the rise of the step (8 inches) and the body represents the tread depth (13 inches).

On the first step, the body line is carried to the bottom edge of the step stringer. This line represents the bottom of the step stringer where it rests on the mudsill once it is cut. The next step is laid out the same way, with the 13-inch mark, as measured along the body of the square, placed at the top edge of the first rise. Once the lines are scribed, this layout is repeated until all the steps in the stairway are scribed onto the step stringer. When the last rise is reached, extend the line to the bottom edge of the step stringer. This line represents the top end of the step stringer where it rests against the bridge stringer once it is cut.

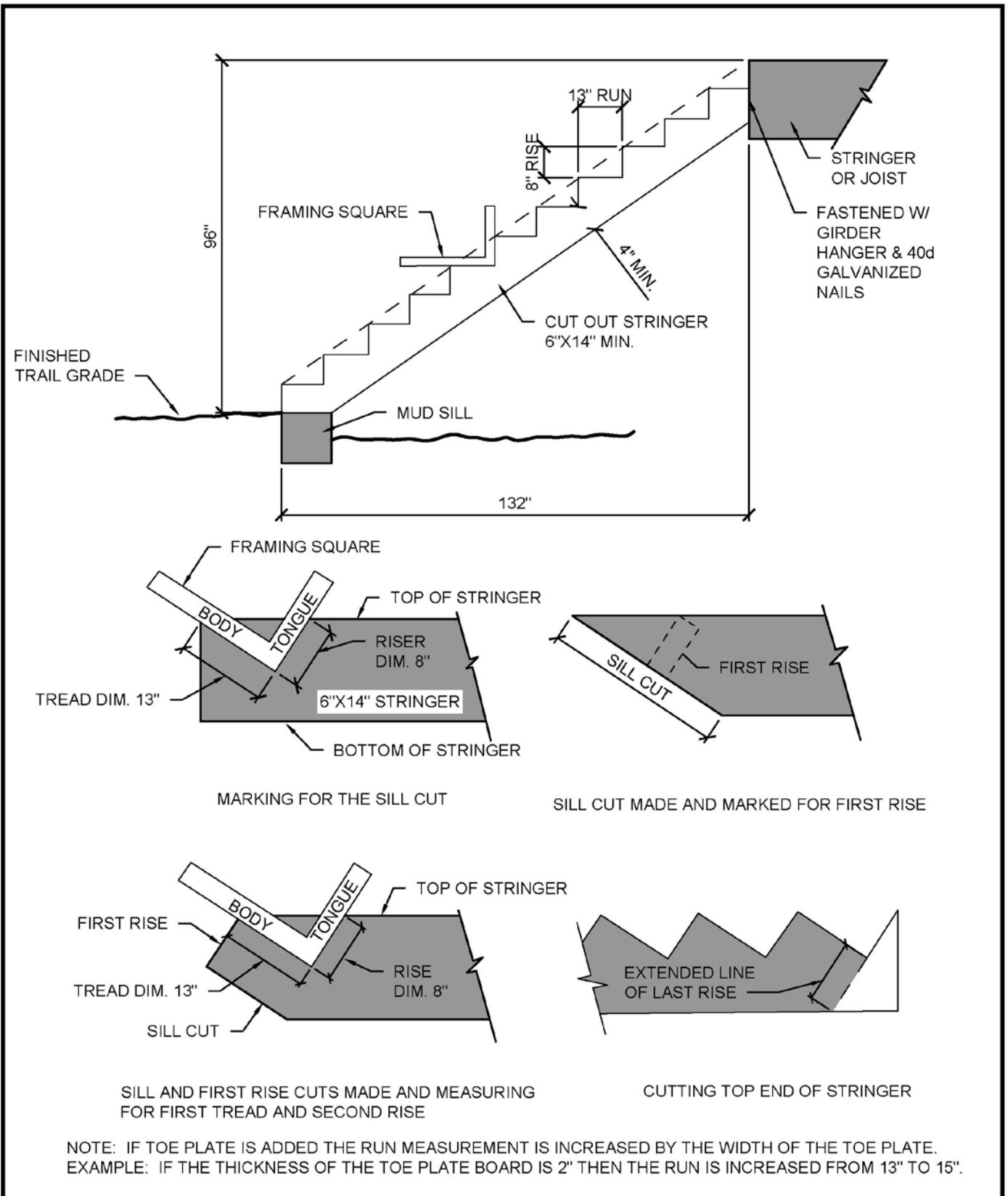

**Figure 17.20 - Cutout Stringer Stairway Layout**



**CUTOUT STRINGER STAIRWAY LAYOUT**

CALIFORNIA STATE PARKS

NOT TO SCALE

When the layout is complete, the height of the bottom step must be shortened by the thickness of the step material. This adjustment is necessary because, for example, when a 3-inch thick step is attached the 8-inch rise of the cut out stringer, the resulting first step will have an 11-inch rise. The cut is made along the bottom of the step stringer where it attaches to the mudsill. Next, the rest of the steps are cut from the step stringer. The minimum depth of wood left below the tread and riser notch is 4 inches. After both step stringers are cut out, they are fastened to the mudsill and the bridge stringers by “toe nailing” with 40d galvanized nails or by using Simpson beam hangers with 40d nails.

The width of the steps is the same as the bridge tread. Tread on the stairway carriage is constructed level in all directions to reduce the chance of slipping when the surface is wet. Water drains off all four edges of the tread. (See Figure 17.21.)

#### 17.4.11. Hardening the Step Approach

For all the step structures identified in this chapter there will be increased mechanical wear to the trail tread approaching the bottom step of the carriage. This area often becomes eroded over time, resulting in the vertical rise of the first step being greater than the designed rise, which can create user discomfort and safety issues. A solution to this problem is to harden the trail tread approaching the bottom step so that it is more resistant to mechanical wear. Hardening can be accomplished by framing the trail tread with wood or rock and installing aggregate surfacing, or by installing a rock armoring (stone pitching) in front of the bottom step. Regardless of the hardening technique used, the hardened approach is installed at trail grade. (See Figure 17.22.)

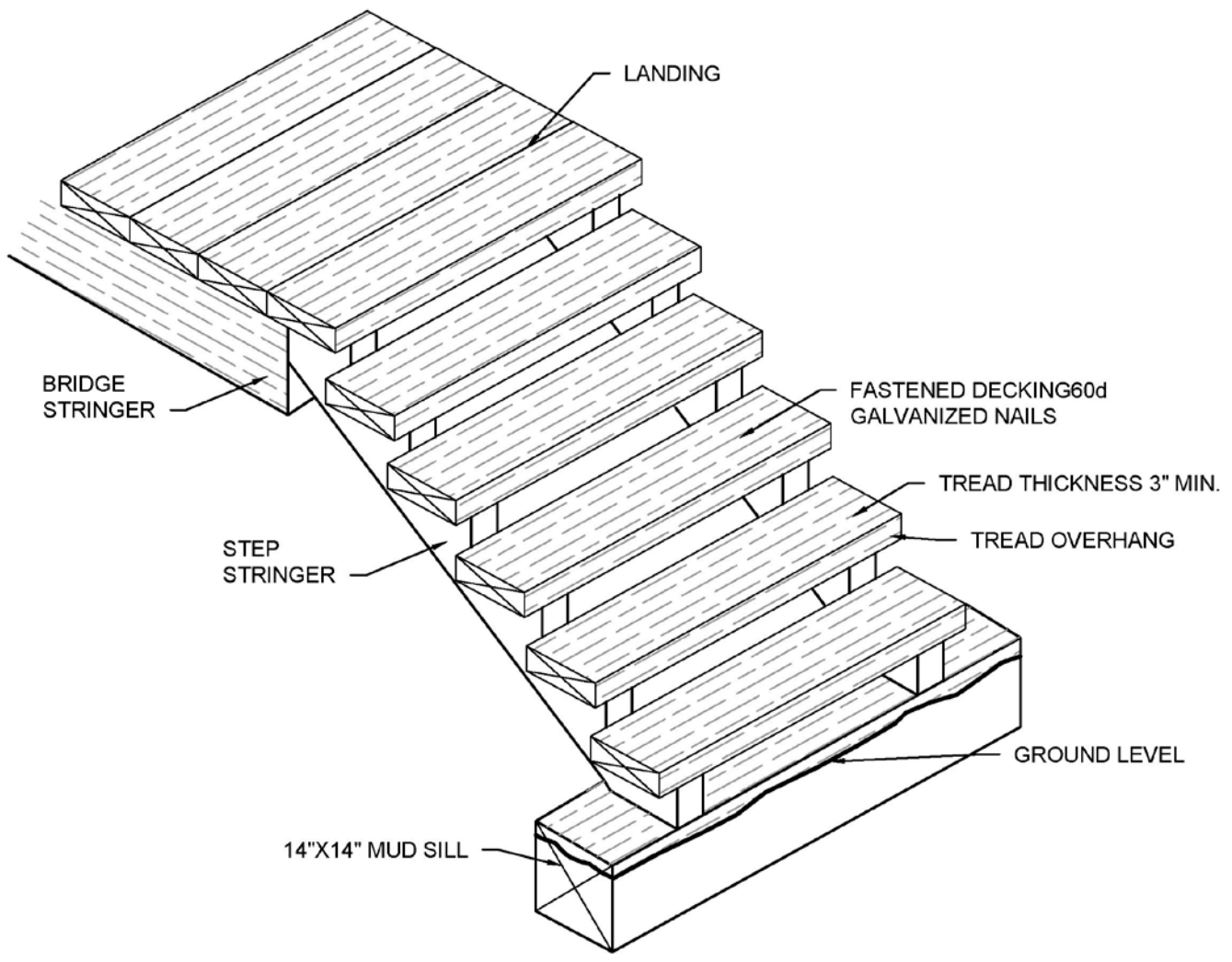

**Figure 17.21 - Cutout Stringer Stairway, Continued**



**CUTOUT STRINGER STAIRWAY CONTINUED**

CALIFORNIA STATE PARKS

NOT TO SCALE

ROCK LANDING (WIDTH VARIES)

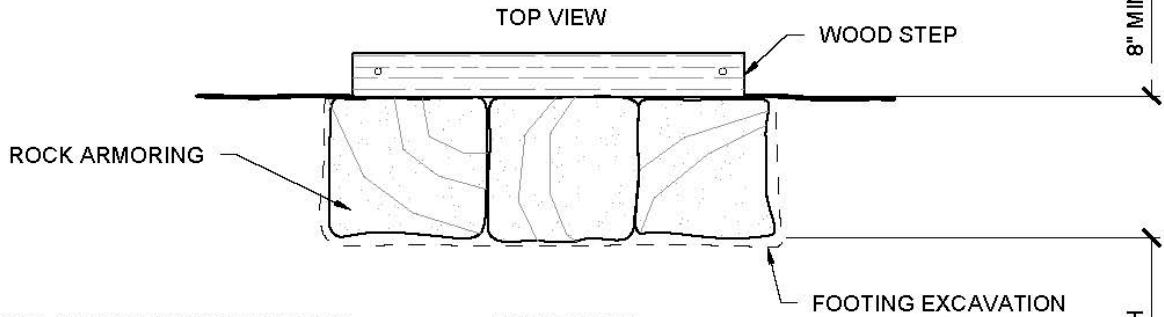
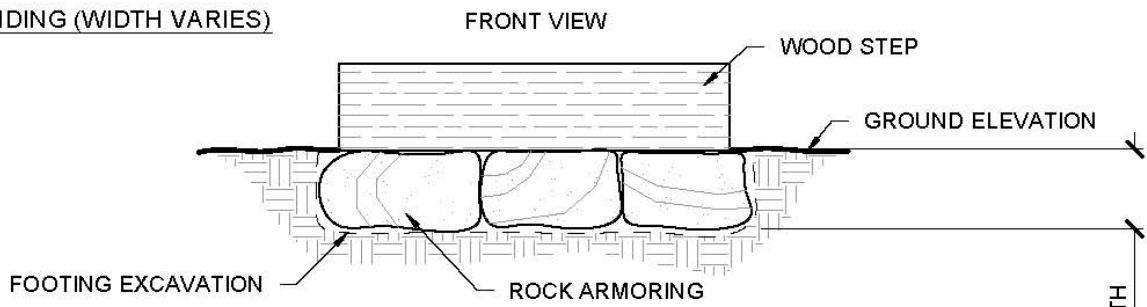

AGGREGATE LANDING (WIDTH VARIES)

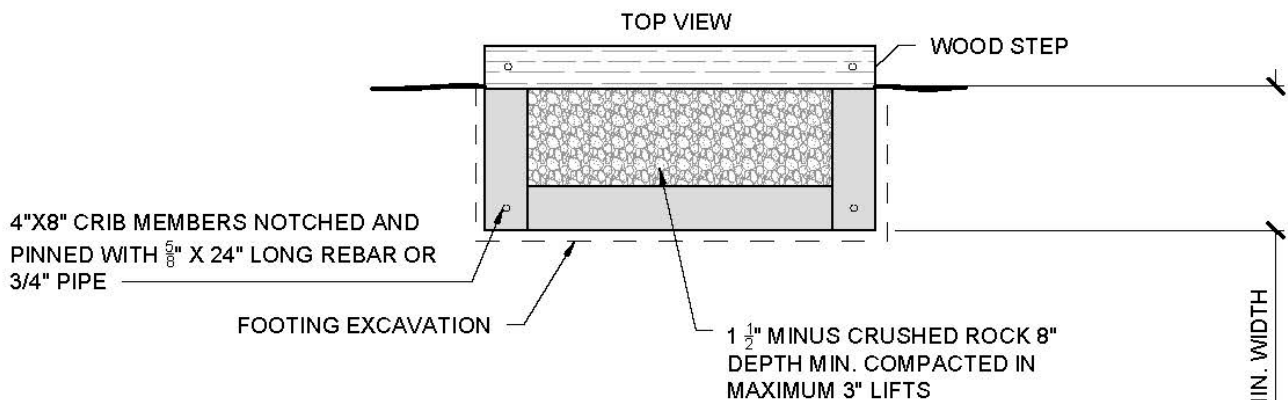
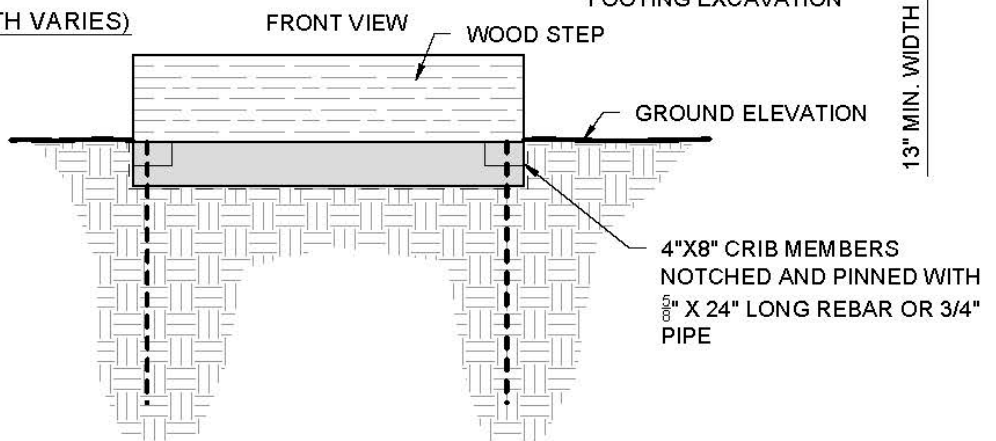

**Figure 17.22 – Hardening the Step Approach**



**HARDENING THE STEP APPROACH**

CALIFORNIA STATE PARKS

NOT TO SCALE